



Protecting  
bystanders  
around the  
work spot

Catalogue  
2025



## CEPRO - PROTECTING PEOPLE AT WORK

CEPRO develops safe setups for welding and grinding sites, to effectively protect people and the surrounding area from danger. Site safety is an indispensable part of solid operational management. In addition, we share our extensive expertise in the field of legal safety requirements with our business relations.

### International market leader

We combine all the knowledge and expertise found in today's sector in our products, services and processes. We treat every request with due care and attention and work to tailor our solutions to the individual requirements of the client or end user. At CEPRO, we consistently invest in knowledge, training and relationships. This allows us to guarantee consistent and dependable quality and solid service in safety that complies with international regulations. It's what has made CEPRO the global market leader in its sector.

### Loyal and highly motivated employees

We don't just go for gold when it comes to safety and satisfied clients. We want the best for our own employees too. And as a result, they tend to be very happy in their jobs. This expresses itself through strong loyalty towards both CEPRO and our business partners, leading to long-term and constructive relationships. Thanks to fixed contacts, our clients and suppliers always know who they are dealing with within our firm – and are very positive about the experience.

In addition, CEPRO's employees are distinguished by their high level of flexibility. This allows them to consistently adapt to new developments in our dynamic society and develop the best possible solutions for the changing needs and wishes of our clients. What's more, these aspects – flexibility, commitment and job satisfaction – can all lead to further cost savings for our clients!

## CEPRO delivers on its promise of dependable quality and service in safety

We do so on the basis of our 6 Ps: Products, People, Protection, Profit, Pure and Planet.

- **Products:** We offer an extensive range of products, training programmes and services that consistently deliver the dependable quality required to set up safe welding and grinding sites in compliance with international legislation.
- **People:** Our employees work to gain an in-depth understanding of our clients' specific requirements, processes and wishes – and enjoy doing so.
- **Protection:** We offer employees optimal protection against welding light, noise and heat. This leads to less absence due to illness, reduced risk of fire and potential production loss as a result of damage.
- **Profit:** For honest business dealings, you need to be able to rely on each other and talk on an equal footing. That's why we work to honour our agreements and remain transparent at all times.
- **Pure:** Coordinating with the client is an integral part of each of our processes. The result? Clear communication.
- **Planet:** And as a firm, it's only logical that we treat the built-up environment in which we use this technology with due care and responsibility. That's why we have drawn up rules on how to behave and set them down in our Code of Conduct. We only work with companies that also attach strong importance to corporate social responsibility and sustainability.

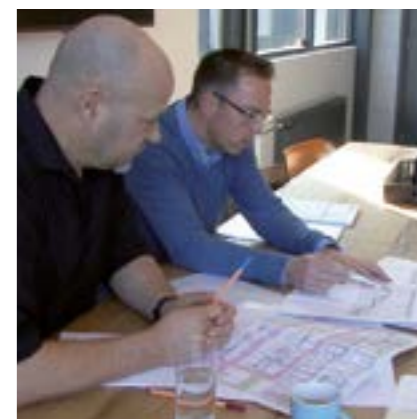

**TABLE OF CONTENTS**

**Welding light**

Welding light product information	page 6
Welding curtains	page 8
Protection curtains	page 11
Welding strips	page 12
Suspension clips & mounting strips	page 13
Accordion folding strip system	page 15
Welding sheet	page 16
Impact plate	page 17

**Welding sparks and spatter**

Sparks and spatter product information	page 18
Premium welding blankets	page 20
Basic welding blankets	page 22
Economy welding blankets	page 24
Carbon felt blankets	page 25
Special blankets	page 26
Blanket accessories	page 27
Insulation products	page 28
Grinding curtains	page 29
Grinding strips	page 30

**Welding screens**

Welding screens product information	page 32
Robusto welding screen	page 34
Omnium welding screen	page 38
Gazelle welding screen	page 42

**TABLE OF CONTENTS**

**Welding and grinding booths**

Booths product information	page 44
Welding booths	page 45
Grinding booths	page 48
Workplace separation	page 49
UniSonic working booths	page 50
UniSonic laser booths	page 52
Welding tables	page 54

**Outdoor welding**

Outdoor welding product information	page 55
Welding umbrella	page 56
Welding tent Light Duty	page 57
Welding tent Heavy Duty	page 59

**Construction**

Construction product information	page 62
Swivel arms	page 64
Poles	page 68
Rail system	page 70
Tube system	page 74
Cable reel	page 77

**WELDING LIGHT**

The main dangers of unprotected exposure to welding light are: actinic conjunctivitis (during short-term exposure), cataract (by prolonged exposure) and skin burn. The latter can also lead to skin cancer. The welder protects himself by wearing a welding mask and protective clothing but bystanders are exposed to the same dangers. This is why it is important to protect bystanders in the work place to prevent long-term illness.

When protecting the welding area, it is important not to isolate it from other work areas which is one of the reasons why a welding curtain should be made of transparent material. This not only helps to keep an overview of the work progress, but also allows for a quick response in the case of emergencies. It also prevents the welder from suffering from claustrophobia.

CEPRO offers a large range of welding light filtration products which all filter harmful welding light.

**Certification**

All CEPRO products have been approved according to the European EN ISO 25980 standard and are regularly retested and re-certified. Therefore customers are always assured of obtaining a safe product.

The standard establishes requirements with regard to:

- Filtration of harmful ultraviolet (UV) and still visible blue light radiation.
- UV stability. This feature allows an approved CEPRO product to offer long term filtration properties.
- Flame extinction; if a CEPRO curtain catches fire, the material will extinguish automatically after the seat of the fire has been extinguished.

CEPRO products offer protection. They prevent actinic conjunctivitis, cataract, burnt skin, create a safe environment for bystanders and considerably reduce medical costs.

**Available colours**

CEPRO supplies transparent welding curtains and strips in three different colours: Cepro Orange Transparent, Cepro Bronze Transparent and Cepro Green Transparent. These colours provide excellent filters against harmful welding light and also offer protection against irritating (not harmful) welding light.

CEPRO also supplies a Dark Green non-transparent. Separations of this material are opaque and extremely suitable for the shielding of several separate welding work areas without causing any nuisance to other welders.

**Available products**

The CEPRO range includes a large variety of products such as:

- Welding curtains for the shielding of large surfaces.
- Welding strips (2 of 3mm thick) for situations where mechanical load-bearing capacity is required.
- Suspension and mounting parts for mounting strips
- Welding sheets (1mm thick) for larger surfaces.
- Impact plate, a hard impact resistant material made of polycarbonate.

Each of these CEPRO products has been developed for use in specific working conditions for the optimal fit-out of a workplace.



**CEPRO WELDING CURTAINS 140CM WIDE**

- Approved in accordance with EN ISO 25980
- Standard width 140 cm
- Fully seamed all-around
- 7 eyelets every on one side measuring 140 cm
- Snap-fasteners on both sides
- Including 7 free steel suspension rings

**CEPRO ORANGE TRANSPARENT WELDING CURTAIN 140 CM WIDE**

H. 160 cm x 140 cm	<b>16.15.16</b>	H. 160 cm x 140 cm	per 10	16.15.16.0010
H. 180 cm x 140 cm	<b>16.15.18</b>	H. 180 cm x 140 cm	per 10	16.15.18.0010
H. 200 cm x 140 cm	<b>16.15.20</b>	H. 200 cm x 140 cm	per 10	16.15.20.0010

**EN ISO 25980  
APPROVED**



Custom-made\* < 10m<sup>2</sup> **16.15.99**  
Custom-made\* > 10m<sup>2</sup> **16.15.99** on demand

\*For conditions custom-made curtains see page 9

**CEPRO DARK GREEN NON-TRANSPARENT WELDING CURTAIN 140 CM WIDE**

H. 160 cm x 140 cm	<b>16.19.16</b>	H. 160 cm x 140 cm	per 10	16.19.16.0010
H. 180 cm x 140 cm	<b>16.19.18</b>	H. 180 cm x 140 cm	per 10	16.19.18.0010
H. 200 cm x 140 cm	<b>16.19.20</b>	H. 200 cm x 140 cm	per 10	16.19.20.0010

**EN ISO 25980  
APPROVED**



Custom-made\* < 10m<sup>2</sup> **16.19.99**  
Custom-made\* > 10m<sup>2</sup> **16.19.99** on demand

\*For conditions custom-made curtains see page 9

**CEPRO GREEN TRANSPARENT WELDING CURTAIN 140 CM WIDE**

H. 160 cm x 140 cm	<b>16.16.16</b>	H. 160 cm x 140 cm	per 10	16.16.16.0010
H. 180 cm x 140 cm	<b>16.16.18</b>	H. 180 cm x 140 cm	per 10	16.16.18.0010
H. 200 cm x 140 cm	<b>16.16.20</b>	H. 200 cm x 140 cm	per 10	16.16.20.0010

**EN ISO 25980  
APPROVED**



Custom-made\* < 10m<sup>2</sup> **16.16.99**  
Custom-made\* > 10m<sup>2</sup> **16.16.99** on demand

\*For conditions custom-made curtains see page 9

**CEPRO BRONZE TRANSPARENT WELDING CURTAIN 140 CM WIDE**

H. 160 cm x 140 cm	<b>16.17.16</b>	H. 160 cm x 140 cm	per 10	16.17.16.0010
H. 180 cm x 140 cm	<b>16.17.18</b>	H. 180 cm x 140 cm	per 10	16.17.18.0010
H. 200 cm x 140 cm	<b>16.17.20</b>	H. 200 cm x 140 cm	per 10	16.17.20.0010

**EN ISO 25980  
APPROVED**



Custom-made\* < 10m<sup>2</sup> **16.17.99**  
Custom-made\* > 10m<sup>2</sup> **16.17.99** on demand

\*For conditions custom-made curtains see page 9

**CONDITIONS CUSTOM-MADE CURTAINS**

- PVC suspension eyelets every 22.5cm
- 5cm seam all-around
- Snap-fasteners on both vertical sides
- Minimum size supplied is 1m<sup>2</sup>
- Minimum length supplied per side is 100cm
- Due to the elasticity of the PVC material, 2 % tolerance should be taken into account on the measurements provided
- The maximum size per curtain is approx. 24m<sup>2</sup> (connectable for larger areas)
- Custom-made curtains are not returnable

**CEPRO WELDING CURTAINS 220CM WIDE**

- Approved in accordance with EN ISO 25980
- Standard width 220 cm
- Fully seamed all-around
- 11 eyelets on one side measuring 220 cm
- Snap-fasteners on both sides
- Including free steel suspension rings

**CEPRO ORANGE TRANSPARENT WELDING CURTAIN 220CM WIDE**

H. 160 cm x 220 cm	18.15.16
H. 180 cm x 220 cm	18.15.18

**EN ISO 25980  
APPROVED**



**CEPRO DARK GREEN NON-TRANSPARENT WELDING CURTAIN 220CM WIDE**

H. 160 cm x 220 cm	18.19.16
H. 180 cm x 220 cm	18.19.18

**EN ISO 25980  
APPROVED**



**CEPRO GREEN TRANSPARENT WELDING CURTAIN 220CM WIDE**

H. 160 cm x 220 cm	18.16.16
H. 180 cm x 220 cm	18.16.18

**EN ISO 25980  
APPROVED**



**CEPRO BRONZE TRANSPARENT WELDING CURTAIN 220CM WIDE**

H. 160 cm x 220 cm	18.17.16
H. 180 cm x 220 cm	18.17.18

**EN ISO 25980  
APPROVED**

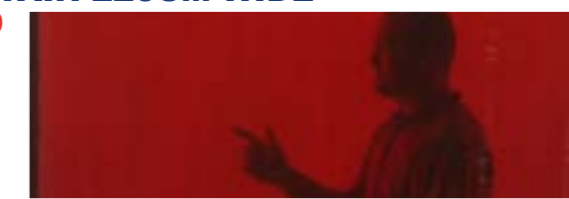

► **CEPRO WELDING CURTAINS EYELETS ALL AROUND**

- Approved in accordance with EN ISO 25980
- Standard height 180cm
- Fully seamed all-around
- Suspension eyelets all around
- Including free steel suspension rings
- Press studs on both sides every 40 cm

► **CEPRO ORANGE TRANSPARENT WELDING CURTAIN 180CM HIGH**

- H. 180 cm x 120 cm (6'x4') 14.15.04
- H. 180 cm x 180 cm (6'x6') 14.15.06
- H. 180 cm x 240 cm (6'x8') 14.15.08

**EN ISO 25980  
APPROVED**



► **CEPRO DARK GREEN NON-TRANSPARENT WELDING CURTAIN 180CM HIGH**

- H. 180 cm x 120 cm (6'x4') 14.19.04
- H. 180 cm x 180 cm (6'x6') 14.19.06
- H. 180 cm x 240 cm (6'x8') 14.19.08

**EN ISO 25980  
APPROVED**



► **CEPRO GREEN TRANSPARENT WELDING CURTAIN 180CM HIGH**

- H. 180 cm x 120 cm (6'x4') 14.16.04
- H. 180 cm x 180 cm (6'x6') 14.16.06
- H. 180 cm x 240 cm (6'x8') 14.16.08

**EN ISO 25980  
APPROVED**



► **CEPRO BRONZE TRANSPARENT WELDING CURTAIN 180CM HIGH**

- H. 180 cm x 120 cm (6'x4') 14.17.04
- H. 180 cm x 180 cm (6'x6') 14.17.06
- H. 180 cm x 240 cm (6'x8') 14.17.08

**EN ISO 25980  
APPROVED**



► **CEPRO WELDING CURTAINS MIXED COLOURS**

- Approved in accordance with EN ISO 25980
- Standard width 150 cm
- Seamed at the top and the bottom
- 7 suspension eyelets on the side measuring 150cm
- Snap-fasteners on both sides
- Including 7 free steel suspension rings
- Colour coverage from the bottom to the top: 40 cm CEPRO Orange Transparent, 120 cm CEPRO Dark Green non-transparent, remainder CEPRO Orange Transparent.

► **CEPRO WELDING CURTAIN MIXED COLOURS**

- H. 160 cm x 150 cm 19.91.16
- H. 180 cm x 150 cm 19.91.18
- H. 200 cm x 150 cm 19.91.20

**EN ISO 25980  
APPROVED**



► **CEPRO PROTECTION CURTAINS 140CM WIDE**

- CEPRO Yellow only provide protection against exposure to UV radiation
- Standard 140 cm wide
- Fully seamed all-around
- 7 eyelets every on one side measuring 140cm
- Snap-fasteners on both sides
- Including 7 free steel suspension rings

► **CEPRO YELLOW UV-CURTAIN 140CM WIDE**

- H. 160 cm x 140 cm 16.11.16
- H. 180 cm x 140 cm 16.11.18
- H. 200 cm x 140 cm 16.11.20



► **CEPRO GRINDING CURTAINS 140CM WIDE - B2 QUALITY**

- H. 160 cm x 140 cm 16.10.16
- H. 180 cm x 140 cm 16.10.18
- H. 200 cm x 140 cm 16.10.20
- H. 220 cm x 140 cm 16.10.22
- H. 240 cm x 140 cm 16.10.24
- H. 260 cm x 140 cm 16.10.26
- H. 280 cm x 140 cm 16.10.28
- H. 300 cm x 140 cm 16.10.30
- Custom-made < 10m<sup>2</sup> 16.10.99
- Custom-made > 10m<sup>2</sup> 16.10.99

**DIN 4102 - B2  
APPROVED**

on demand



► **CEPRO GRINDING CURTAINS 140CM WIDE - B1 QUALITY**

- H. 160 cm x 140 cm 16.30.16
- H. 180 cm x 140 cm 16.30.18
- H. 200 cm x 140 cm 16.30.20
- H. 220 cm x 140 cm 16.30.22
- H. 240 cm x 140 cm 16.30.24
- H. 260 cm x 140 cm 16.30.26
- H. 280 cm x 140 cm 16.30.28
- H. 300 cm x 140 cm 16.30.30
- Custom-made < 10m<sup>2</sup> 16.30.99
- Custom-made > 10m<sup>2</sup> 16.30.99

**DIN 4102 - B1  
APPROVED**

on demand



► **CEPRO WELDING STRIPS**

- Approved in accordance with EN ISO 25980
- Standard 300 mm wide
- 2 mm and 3 mm thickness
- Full roll 50 meters
- Available cut and punched
- Plastic suspension clips

► **CEPRO ORANGE TRANSPARENT WELDING STRIPS**

300 x 2 mm uncut per meter	26.25.02
300 x 3 mm uncut per meter	26.25.03
300 x 2 mm uncut per full roll	26.25.02.0050
300 x 3 mm uncut per full roll	26.25.03.0050

300 x 2 mm cut to size and punched according to the CEPRO pattern minimum length 150 cm	26.25.02.91
300 x 3 mm cut to size and punched according to the CEPRO pattern minimum length 150 cm	26.25.03.91

**EN ISO 25980  
APPROVED**



► **CEPRO DARK GREEN NON-TRANSPARENT WELDING STRIPS**

300 x 2 mm uncut per meter	26.29.02
300 x 3 mm uncut per meter	26.29.03
300 x 2 mm uncut per full roll	26.29.02.0050
300 x 3 mm uncut per full roll	26.29.03.0050

300 x 2 mm cut to size and punched according to the CEPRO pattern minimum length 150 cm	26.29.02.91
300 x 3 mm cut to size and punched according to the CEPRO pattern minimum length 150 cm	26.29.03.91

**EN ISO 25980  
APPROVED**



► **CEPRO GREEN TRANSPARENT WELDING STRIPS**

300 x 2 mm uncut per meter	26.26.02
300 x 2 mm uncut per full roll	26.26.02.0050

300 x 2 mm cut to size and punched according to the CEPRO pattern minimum length 150 cm	26.26.02.91
---	-------------

**EN ISO 25980  
APPROVED**



► **CEPRO BRONZE TRANSPARENT WELDING STRIPS**

300 x 2 mm uncut per meter	26.27.02
300 x 2 mm uncut per full roll	26.27.02.0050

300 x 2 mm cut to size and punched according to the CEPRO pattern minimum length 150 cm	26.27.02.91
---	-------------

**EN ISO 25980  
APPROVED**



► **CEPRO SUSPENSION CLIPS**

- Easy assembly of welding strips on a tube Ø 33.7 mm
- Suitable for overlap of 5 and 10 cm
- Easy to open and close on the folding line



► **CEPRO STANDARD SUSPENSION CLIP 20 CM**

Standard clip 20 cm 20.11.01

To be used on the overlap of the strips. The clip can be unfolded on the fold line, for quick and easy installation.

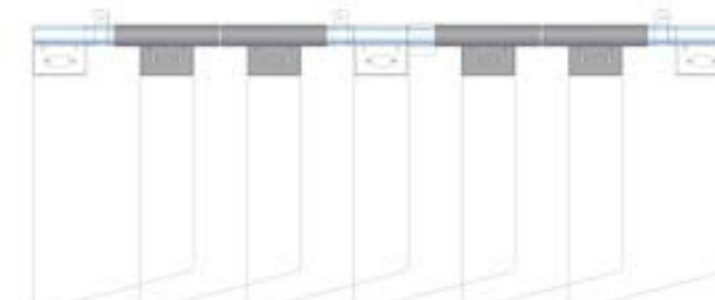

10 cm / 66% overlap (2 holes overlap)

► **CEPRO SQUARE SUSPENSION CLIP 10 CM**

Square clip 10 cm 20.11.09

Suspension clip to be used as initial clip in a separation or next to a support.

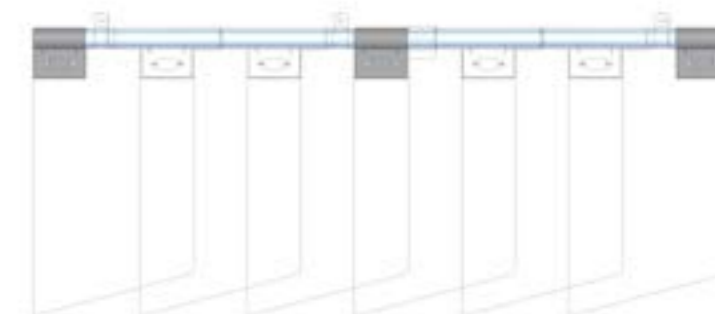

10 cm / 66% overlap (2 holes overlap)

► **CEPRO FILLING PIECE 5 CM**

Filling piece 5 cm 20.11.90

Filling piece, for overlap of 5 cm or next to a support in combination with a square clip.

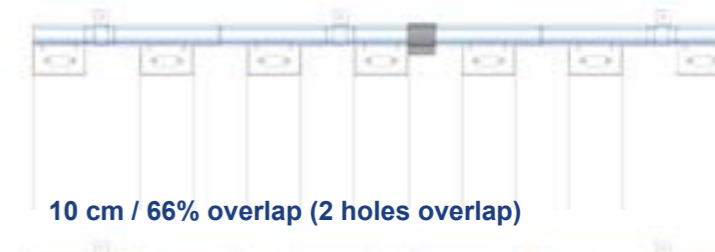

5 cm / 33% overlap (1 hole overlap)

▶ **10cm / 66% overlap**  
(2 holes overlap)

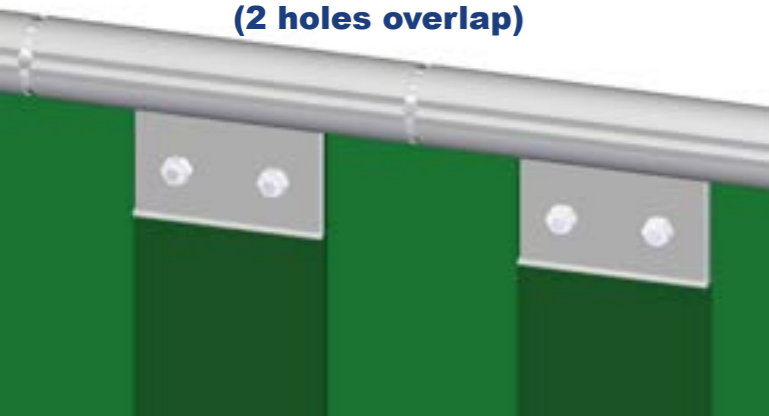

▶ **5cm / 33% overlap**  
(1 hole overlap)

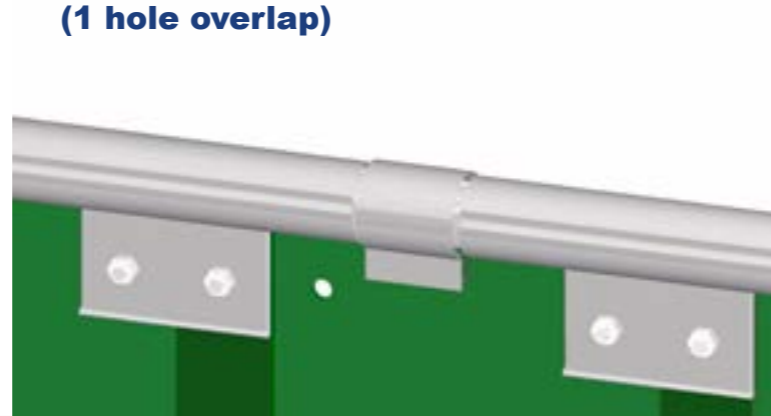

1 ▶ Open the clip on the folding line.



2 ▶ Press the clip onto the tube.



3 ▶ Push the bolts through both of the round holes in the middle of the clip.



4 ▶ Slide the overlapping strips over the bolts. Alternately assemble the strips concavely and convexly. For a 10cm overlap use both pre-punched holes and for a 5cm overlap only use the outer holes.



5 ▶ Close the clips and tighten the nuts and bolts.



6 ▶ If you have used a 5cm overlap then you can use the filling pieces in the openings between the clips.



**Calculation diagram for strip separations with an overlap of 100 mm (66%)**

Width separation (mm)	900	1100	1300	1500	1700	1900	2100	2300	2500	2700	2900	3100	3300	3500	3700	3900	4100	4300	4500	4700	4900	5100	5300	5500	5700	5900	6100	6300	6500
Number strips	4	5	6	7	8	9	10	11	12	13	14	15	16	17	18	19	20	21	22	23	24	25	26	27	28	29	30	31	32
Number standard clips	3	4	5	6	7	7	8	9	10	11	12	12	13	14	15	16	16	17	18	19	20	20	21	22	23	24	24	25	26
Number square clips	2	2	2	2	2	3	3	3	3	3	3	4	4	4	4	4	5	5	5	5	5	6	6	6	6	6	7	7	7
Number filling pieces	2	2	2	2	2	4	4	4	4	4	4	6	6	6	6	6	8	8	8	8	8	10	10	10	10	10	12	12	12

**Calculation diagram for strip separations with an overlap of 50 mm (33%)**

Width separation (mm)	800	1050	1300	1550	1800	2050	2300	2550	2800	3050	3300	3550	3800	4050	4300	4550	4800	5050	5300	5550	5800	6050	6300	6550	6800	7050	7300	7550	7800
Number strips	3	4	5	6	7	8	9	10	11	12	13	14	15	16	17	18	19	20	21	22	23	24	25	26	27	28	29	30	31
Number standard clips	2	3	4	5	6	7	8	9	10	11	12	13	14	15	16	17	18	19	20	21	22	23	24	25	26	27	28	29	30
Number square clips	2	2	2	2	2	2	2	2	2	2	2	2	2	2	2	2	2	2	2	2	2	2	2	2	2	2	2	2	2
Number filling pieces	4	5	6	7	8	9	10	11	12	13	14	15	16	17	18	19	20	21	22	23	24	25	26	27	28	29	30	31	32

▶ **CEPRO ACCORDION FOLDING STRIP SYSTEM**

- Minimum amount of space
- Easy to operate
- Flexible in dividing the workspace



**CEPRO SUSPENSION FOLDING STRIP SYSTEM**

Complete mounting set for folding strips system, per running meter. Including all supports for mounting the system under a ceiling.

Cepro folding strip mounting system 20.95.95

Minimum width : 130 cm  
Maximum width : 1,000 cm



▶ **CEPRO STRIPS FOLDING STRIP SYSTEM**

Complete strip set for accordion folding strip system per square meter.  
**Thickness strips 2 mm. Maximum strip height 350 cm.**

- Cepro Orange Transparent folding strip 300x2 mm system 27.55.32.10
- Cepro Dark Green non-transparent folding strip 300x2 mm system 27.59.32.10
- Cepro Bronze Transparent folding strip 300x2 mm system 27.57.32.10
- Cepro Green Transparent folding strip 300x2 mm system 27.56.32.10

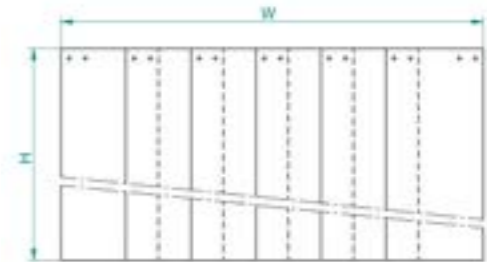

▶ **CEPRO STRIPS FOLDING STRIP SYSTEM**

Complete strip set for accordion folding strip system per square meter.  
**Thickness strips 3 mm. Maximum strip height 250 cm.**

- Cepro Orange Transparent folding strip 300x3 mm system 27.55.33.10
- Cepro Dark Green non-transparent folding strip 300x3 mm system 27.59.33.10

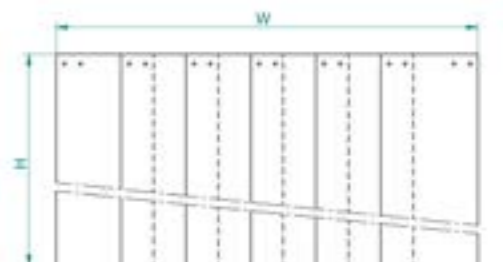



**CEPRO WELDING SHEET 1 MM**

- Approved in accordance with EN ISO 25980
- Standard 570 mm wide
- 1 mm thickness
- Full roll 50 meters
- 4 eyelets every on one side measuring 570 mm
- Metal suspension rings included
- Packed 4 per box, working width per box 2 meters
- Supplied rolled in paper

**CEPRO ORANGE TRANSPARENT WELDING SHEET 1 MM**

570 x 1mm, roll 50 meter length 22.15.01

Working width per box 200 cm.

570 x 1 x 1,600 mm, per 4 pieces 22.15.16.0004  
570 x 1 x 1,800 mm, per 4 pieces 22.15.18.0004  
570 x 1 x 2,000 mm, per 4 pieces 22.15.20.0004  
570 x 1 x 2,200 mm, per 4 pieces 22.15.22.0004

**EN ISO 25980  
APPROVED**



**CEPRO IMPACT PLATE 3 MM**

- Approved in accordance with EN ISO 25980
- Hard impact resistant material
- 3 mm thickness
- Polycarbonate
- Available in custom measurements.

**CEPRO IMPACT BRONZE**

2,050 X 1,250 mm, thickness 3 mm 28.27.01  
1,025 X 1,250 mm, thickness 3 mm 28.27.05

Impact cut to size per square meter 20.95.28.0001 on demand

**EN ISO 25980  
APPROVED**



**CEPRO DARK GREEN NON-TRANSPARENT WELDING SHEET 1 MM**

570 x 1 mm, roll 50 meter length 22.19.01

Working width per box 200 cm.

570 x 1 x 1,600 mm, per 4 pieces 22.19.16.0004  
570 x 1 x 1,800 mm, per 4 pieces 22.19.18.0004  
570 x 1 x 2,000 mm, per 4 pieces 22.19.20.0004  
570 x 1 x 2,200 mm, per 4 pieces 22.19.22.0004

**EN ISO 25980  
APPROVED**



**CEPRO IMPACT GREEN**

2,050 X 1,250 mm, thickness 3 mm 28.29.01  
1,025 X 1,250 mm, thickness 3 mm 28.29.05

Impact cut to size per square meter 20.95.28.0001 on demand

**EN ISO 25980  
APPROVED**



**CEPRO GREEN TRANSPARENT WELDING SHEET 1 MM**

570 x 1 mm, roll 50 meter length 22.16.01

Working width per box 200 cm.

570 x 1 x 1,600 mm, per 4 pieces 22.16.16.0004  
570 x 1 x 1,800 mm, per 4 pieces 22.16.18.0004  
570 x 1 x 2,000 mm, per 4 pieces 22.16.20.0004  
570 x 1 x 2,200 mm, per 4 pieces 22.16.22.0004

**EN ISO 25980  
APPROVED**



**CONDITIONS CUSTOM-CUT IMPACT**

- Minimum calculated dimension 0.25m<sup>2</sup>
- Minimum length calculated is 50 cm
- Custom cut Impact is not returnable

**CEPRO BRONZE TRANSPARENT WELDING SHEET 1 MM**

570 x 1 mm, roll 50 meter length 22.17.01

Working width per box 200 cm.

570 x 1 x 1,600 mm, per 4 pieces 22.17.16.0004  
570 x 1 x 1,800 mm, per 4 pieces 22.17.18.0004  
570 x 1 x 2,000 mm, per 4 pieces 22.17.20.0004  
570 x 1 x 2,200 mm, per 4 pieces 22.17.22.0004

**EN ISO 25980  
APPROVED**



**CEPRO IMPACT PLATE SPECIALS**

CEPRO Impact material is also available in the colour Clear.

For more information, feel free to ask our sales department for a quotation.



**▶ SPARKS AND SPATTER**

Welding and grinding sparks are a significant issue and pose hazards for welders and co-workers in the welding and grinding workplace. Not only can sparks cause burns and thus serious personal injury to workers, but they can also cause a significant potential loss to the production process which can have a negative influence on the work of other personnel.

One of the major costs of inadequately protecting the working environment from sparks and welding spatters is damage during production which affects quality. Sparks and welding spatters pose a serious fire risk. It is not without reason that many insurers set demands for covering and shielding of flammable and / or costly materials in the vicinity of welding and grinding worksites.

Effective protection of products from welding spatter requires the use of non-combustible materials. This needs careful consideration. Specific applications and work situations often require unique solutions and customized products. Only tested and approved products should be chosen for maximum security against liability. CEPRO can provide these quality products.

CEPRO offers an extensive product package to provide shielding against sparks and welding spatters. The choice depends on the type of risk, the frequency of use, the proximity of the spark source and the different environmental factors. Products can be supplied for horizontal applications (welding blankets) or vertical solutions (curtains). Often it is also necessary and possible to supply custom made products.

**▶ Certification**

The European standard EN 13501-1 provides the reaction to fire classification procedure for all products and building elements. According to this standard, reaction to fire is the response of a product in contributing by its own decomposition to a fire to which it is exposed, under specified conditions (not to be confused with the fire resistance).

All CEPRO welding blankets comply with the most stringent requirements for each quality. We hereby guarantee our clients a high-quality product, which will ensure a safe workplace, at all times.

For the best possible guarantee against liability, one must select products that are tested and approved according to the above mentioned standard.

**▶ Available products**

The CEPRO range includes a large variety of products such as:

- Premium welding blankets, produced from high quality raw material.
- Basic welding blankets, all-round blankets with an excellent price - quality ratio.
- Economy welding blankets, combine quality with a competitive price.
- Carbon felt welding blankets, light weight, scratch free and flexible.
- Specials, door sleeves, protection covers
- Insulation products, welding cushions, insulation blankets and sleeves.
- Clear grinding strips and curtains.

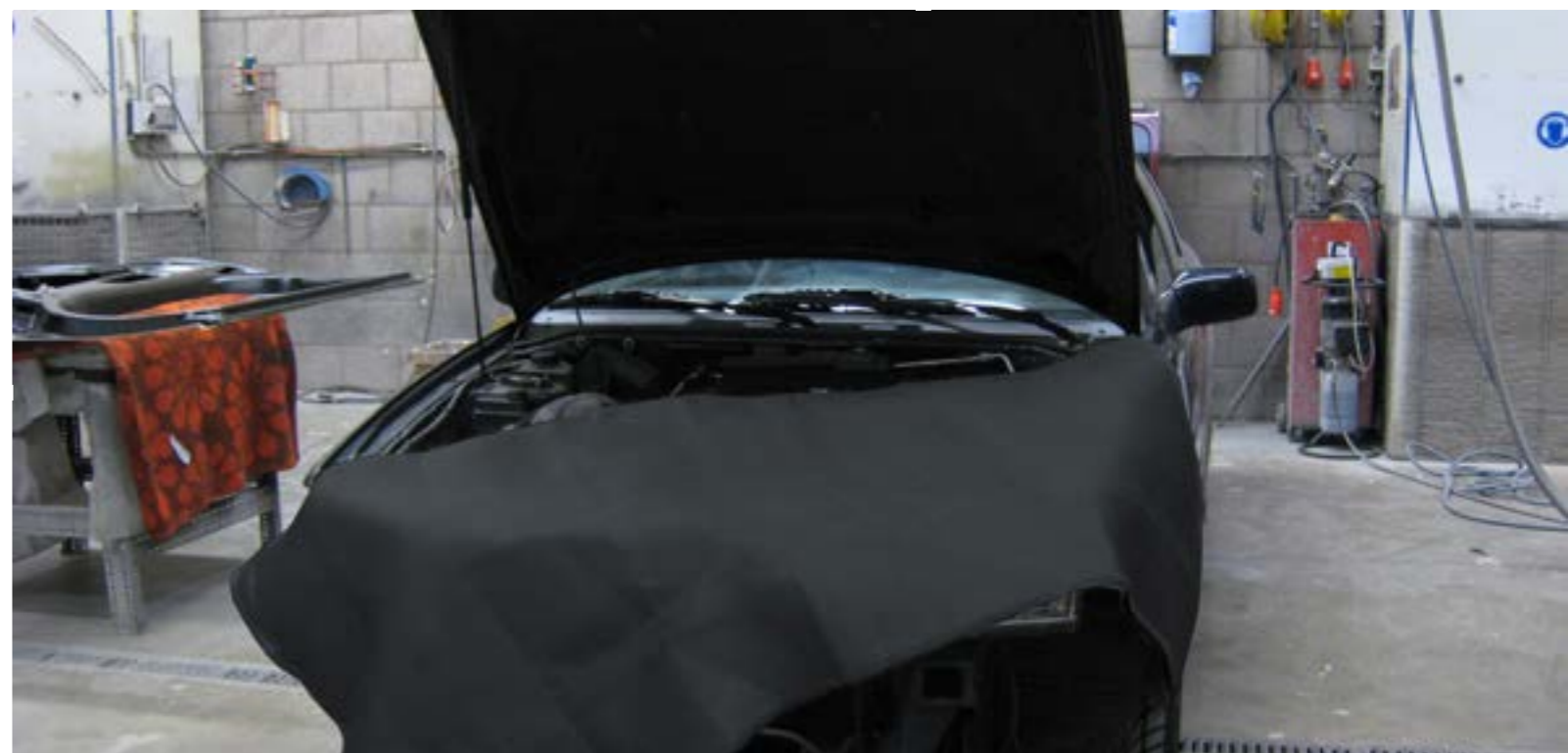
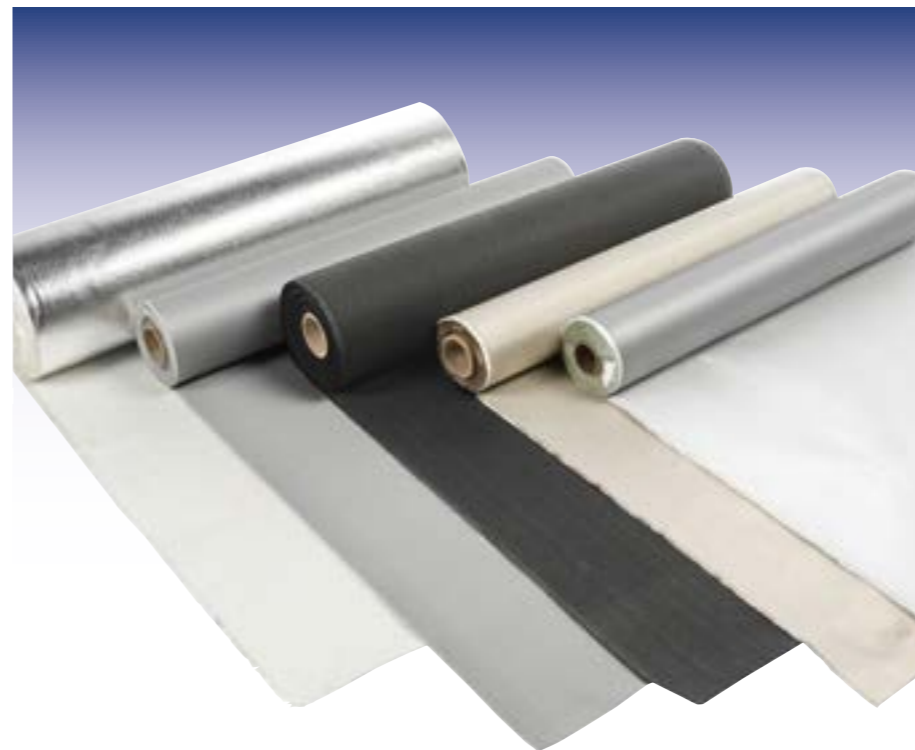
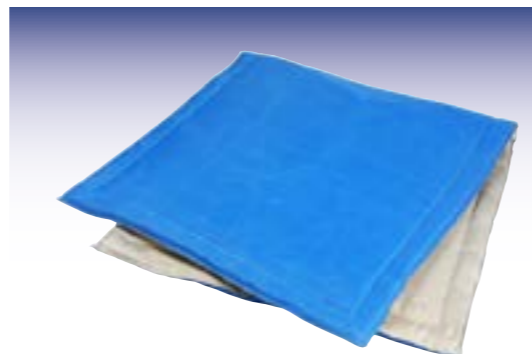
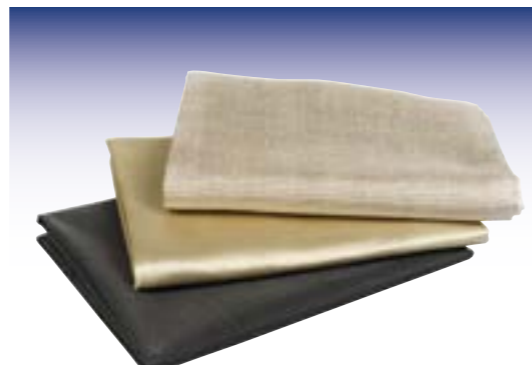

**CEPRO PREMIUM WELDING BLANKETS**

- Approved according to the highest applicable classification within the EN 13501-1 standard
- Suitable for horizontal and vertical use
- Produced from high-quality materials
- Suitable for high to extremely high temperatures

**OLYMPUS WELDING BLANKET**

Olympus welding blanket 90 x 100 cm	56.50.91
Olympus welding blanket 90 x 200 cm	56.50.92
Olympus welding blanket 180 x 200 cm	56.50.95
Olympus welding blanket 180 x 300 cm	56.50.96
Olympus welding blanket 270 x 300 cm	56.50.97
Olympus welding blanket 360 x 400 cm	56.50.99
Olympus welding blanket 360 x 600 cm	56.50.992
Olympus width 90 cm, part of a rol	56.50.09.0900
Olympus width 90 cm, full rol 50 m <sup>1</sup>	56.50.09.0950
Olympus made to size, seamed	56.50.90

**A1 - EN 13501-1 approved non-flammable**

- Silica fabric (filament)
- High temperatures up to 1000 °C
- Peak temperature approx. 1300°C
- Extreme circumstances
- Suitable for horizontal use
- Material weight 1,220 gram/m<sup>2</sup>



**CEPRO PREMIUM WELDING BLANKETS**

- Approved according to the highest applicable classification within the EN 13501-1 standard
- Suitable for horizontal and vertical use
- Produced from high-quality materials
- Suitable for high to extremely high temperatures

**ATHOS WELDING BLANKET**

Athos welding blanket 200 x 200 cm	56.55.15
Athos welding blanket 300 x 200 cm	56.55.16
Athos welding blanket 300 x 400 cm	56.55.18
Athos welding blanket 400 x 400 cm	56.55.19
Athos width 100cm, part of a rol	56.55.10.1000
Athos width 100cm, full rol 25 m <sup>1</sup>	56.55.10.1025

**A2, s1, d0 EN 13501-1 approved non-flammable**

- Fibreglass cloth (texturized)
- 2-sided PU coating
- Temperature resistance 550°C
- Peak temperature approx. 900°C
- Material weight 1,120 gram/m<sup>2</sup>



**HERCULES WELDING BLANKET**

Hercules welding blanket 100 x 100 cm	56.50.71
Hercules welding blanket 200 x 100 cm	56.50.72
Hercules welding blanket 200 x 200 cm	56.50.75
Hercules welding blanket 200 x 300 cm	56.50.76
Hercules welding blanket 300 x 300 cm	56.50.77
Hercules welding blanket 400 x 300 cm	56.50.78
Hercules welding blanket 400 x 400 cm	56.50.79
Hercules width 100 cm, part of a rol	56.50.07.1000
Hercules width 100 cm, full rol 25 m <sup>1</sup>	56.50.07.1025
Hercules made to size, lock stiched	56.50.70

**A2, s1, d0 EN 13501-1 approved non-flammable**

- Fibreglass cloth (texturized)
- 2-sided PU coating
- Temperature resistance 750°C
- Peak temperature approx. 900°C
- Suitable for horizontal use
- Material weight 1,220 gram/m<sup>2</sup>



**ARES WELDING BLANKET**

Ares width 100 cm, part of a rol	56.51.01.1000
Ares width 100 cm, full rol 50 m <sup>1</sup>	56.51.01.1050

**A2, s1, d0 EN 13501-1 approved non-flammable**

- Fibreglass cloth (texturized)
- 1 sided aluminium foil
- Temperature resistance 550°C
- Contact temperature adhesive 180°C
- Radiation temperature 1.000°C
- Protection against radiation heat
- Material weight 1,060 gram/m<sup>2</sup>



**SIRIUS WELDING BLANKET**

Sirius welding blanket 100 x 100 cm	56.53.21
Sirius welding blanket 200 x 100 cm	56.53.22
Sirius welding blanket 200 x 200 cm	56.53.25
Sirius welding blanket 200 x 300 cm	56.53.26
Sirius welding blanket 300 x 300 cm	56.53.27
Sirius welding blanket 400 x 400 cm	56.53.29
Sirius width 100 cm, part of a rol	56.53.02.1000
Sirius width 100 cm, full rol 25 m <sup>1</sup>	56.53.02.1025
Sirius made to size, seamed	56.53.20

**A1 - EN 13501-1 approved non-flammable**

- Fibreglass cloth (texturized)
- 2-sided HT coating
- Flame protection till approx. 700 °C
- Peak temperature approx. 1000°C
- Suitable for horizontal use
- Material weight 1,035 gram/m<sup>2</sup>



**CONDITIONS CUSTOM-MADE WELDING BLANKETS**

The specifications for custom-made welding blankets are:

- Sewn on the cut edges.
- Minimum size available is 1m<sup>2</sup>.
- Maximum size available is 15m<sup>2</sup>.
- The minimum length per side is 100 cm.
- Welding blankets are made with tolerance of 2% with a maximum of 5 cm on the provided measurements
- Custom-made welding blankets are not returnable

**THETIS WELDING BLANKET**

Thetis welding blanket 200 x 100 cm	56.53.82
Thetis welding blanket 200 x 200 cm	56.53.85
Thetis welding blanket 200 x 300 cm	56.53.86
Thetis welding blanket 300 x 300 cm	56.53.87
Thetis welding blanket 300 x 400 cm	56.53.88
Thetis welding blanket 400 x 400 cm	56.53.89
Thetis welding blanket 400 x 600 cm	56.53.892
Thetis width 100 cm, part of a rol	56.53.08.1000
Thetis width 100 cm, full rol 25 m <sup>1</sup>	56.53.08.1025
Thetis made to size, lock stiched	56.53.80

**A2, s2, d0 EN 13501-1 approved non-flammable**

- Fibreglass cloth (texturized)
- 2-sided black graphite coating
- Temperature resistance 700°C
- Peak temperature 900°C
- Suitable for horizontal use
- Material weight 1,100 gram/m<sup>2</sup>



**PRODUCT FACT SHEETS**

**i** For all materials product fact sheets are available with information about composition, tests etc.

Please visit our website or contact our sales department for more information.



**CEPRO BASIC WELDING BLANKETS**

- Approved according to the highest applicable classification within the EN 13501-1 standard
- Suitable for vertical use
- Excellent price-quality ratio
- All-round welding blankets

**LETO WELDING BLANKET**

Leto welding blanket 90 x 100 cm	56.51.91
Leto welding blanket 90 x 200 cm	56.51.92
Leto welding blanket 180 x 200 cm	56.51.95
Leto welding blanket 180 x 300 cm	56.51.96
Leto welding blanket 270 x 300 cm	56.51.97
Leto width 90 cm, part of a rol	56.51.09.0900
Leto width 90 cm, full rol 50 m <sup>1</sup>	56.51.09.0950
Leto made to size, seamed	56.51.90

**A1 - EN 13501-1 approved non-flammable**

- Silica fabric (filament)
- High temperatures up to 1000 °C
- Peak temperature approx. 1300°C
- Extreme circumstances
- Suitable for horizontal use
- Material weight 600 gram/m<sup>2</sup>



**CEPRO BASIC WELDING BLANKETS**

- Approved according to the highest applicable classification within the EN 13501-1 standard
- Suitable for vertical use
- Excellent price-quality ratio
- All-round welding blankets

**KRONOS WELDING BLANKET**

Kronos welding blanket 200 x 100 cm	56.50.62
Kronos welding blanket 200 x 200 cm	56.50.65
Kronos welding blanket 300 x 200 cm	56.50.66
Kronos welding blanket 300 x 300 cm	56.50.67
Kronos welding blanket 300 x 400 cm	56.50.68
Kronos welding blanket 400 x 400 cm	56.50.69
Kronos welding blanket 400 x 600 cm	56.50.692
Kronos width 100 cm, part of a rol	56.50.06.1000
Kronos width 100 cm, full rol 25 m <sup>1</sup>	56.50.06.1025
Kronos width 150 cm, part of a rol	56.50.06.1500
Kronos width 150 cm, full rol 50 m <sup>1</sup>	56.50.06.1550
Kronos made to size, seamed	56.50.60

**A2, s1, d0 EN 13501-1 approved non-flammable**

- Fibreglass cloth (filament)
- 1-sided PU-coating
- Temperature resistance 550°C
- Peak temperature approx. 600°C
- Light welding and grinding work
- Material weight 690 gram/m<sup>2</sup>



**PALLAS WELDING BLANKET**

Pallas welding blanket 100 x 100 cm	56.50.41
Pallas welding blanket 200 x 100 cm	56.50.42
Pallas welding blanket 200 x 200 cm	56.50.45
Pallas welding blanket 200 x 300 cm	56.50.46
Pallas welding blanket 300 x 300 cm	56.50.47
Pallas welding blanket 400 x 300 cm	56.50.48
Pallas welding blanket 400 x 400 cm	56.50.49
Pallas width 100 cm, part of a rol	56.50.04.1000
Pallas width 100 cm, full rol 25 m <sup>1</sup>	56.50.04.1025
Pallas made to size, seamed	56.50.40

**A1 - EN 13501-1 approved non-flammable**

- Fibreglass cloth (filament)
- 2-sided inorganic HT coating
- Temperature resistance 700°C
- Peak temperature approx. 750°C
- Suitable for welding and grinding
- Material weight 700 gram/m<sup>2</sup>



**ARGES WELDING BLANKET**

Arges width 100 cm, full rol 50 m <sup>1</sup>	56.59.14.1050
--	---------------

- Fibreglass cloth (filament)
- 2-sided neoprene rubber coating
- Temperature resistance 550°C
- Peak temperature approx. 600°C
- Oil, grease and acid resistant
- Material weight 550 gram/m<sup>2</sup>.



**ASTERIA WELDING BLANKET**

Asteria welding blanket 200 x 100 cm	56.53.72
Asteria welding blanket 200 x 200 cm	56.53.75
Asteria welding blanket 200 x 300 cm	56.53.76
Asteria width 100 cm, part of a rol	56.53.07.1000
Asteria width 100 cm, full rol 25 m <sup>1</sup>	56.53.07.1025
Asteria made to size, seamed	56.53.70

**A1 - EN 13501-1 approved non-flammable**

- Fibreglass cloth (texturized)
- 2-sided heat treated
- Temperature resistance 550°C
- Peak temperature approx. 600°C
- Light welding and grinding work
- Material weight 580 gram/m<sup>2</sup>

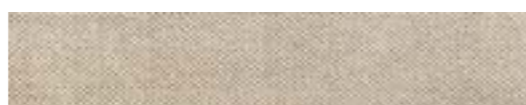

**CONDITIONS CUSTOM-MADE WELDING BLANKETS**

The specifications for custom-made welding blankets are:

- Sewn on the cut edges.
- Minimum size available is 1m<sup>2</sup>.
- Maximum size available is 15m<sup>2</sup>.
- The minimum length per side is 100 cm.
- Welding blankets are made with 5 cm tolerance on the provided measurements
- Custom-made welding blankets are not returnable

**ATLAS WELDING BLANKET**

Atlas welding blanket 200 x 100 cm	56.50.12
Atlas welding blanket 200 x 200 cm	56.50.15
Atlas welding blanket 300 x 200 cm	56.50.16
Atlas welding blanket 300 x 300 cm	56.50.17
Atlas welding blanket 300 x 400 cm	56.50.18
Atlas welding blanket 400 x 400 cm	56.50.19
Atlas width 100 cm, part of a rol	56.50.05.1000
Atlas width 100 cm, full rol 25 m <sup>1</sup>	56.50.05.1025
Atlas width 150 cm, part of a rol	56.50.05.1500
Atlas width 150 cm, full rol 50 m <sup>1</sup>	56.50.05.1550
Atlas made to size, lock stiched	56.50.10

**A2, s1, d0 EN 13501-1 approved non-flammable**

- Fibreglass cloth (filament)
- 2-sided PU-coating
- Temperature resistance 550 °C
- Peak temperature approx. 600°C
- Light welding and grinding work
- Material weight 720 gram/m<sup>2</sup>



**BIGGER QUANTITIES**

**i** If you have any demand for bigger quantities in blankets or rolls, please contact our sales department for a quotation.



► **CEPRO ECONOMY WELDING BLANKETS**

- Approved according to the highest applicable classification within the EN 13501-1 standard
- Suitable for vertical use
- CEPRO quality at a competitive price
- Suitable for light welding and grinding work

► **ATHENA WELDING BLANKET**

Athena welding blanket 100 x 100 cm	56.52.21
Athena welding blanket 200 x 100 cm	56.52.22
Athena welding blanket 200 x 200 cm	56.52.25
Athena welding blanket 200 x 300 cm	56.52.26
Athena welding blanket 300 x 300 cm	56.52.27
Athena welding blanket 400 x 400 cm	56.52.29
Athena welding blanket 400 x 600 cm	56.52.292
Athena width 100 cm, part of a rol	56.52.02.1000
Athena width 100 cm, full rol 25 m <sup>1</sup>	56.52.02.1025
Athena width 100 cm, full rol 50 m <sup>1</sup>	56.52.02.1050
Athena made to size, seamed	56.52.20

**A2, s1, d0 EN 13501-1 approved non-flammable**

- Fibreglass cloth (filament)
- 2-sided PU-coating
- Temperature resistance 550°C
- Peak temperature approx. 600°C
- Light welding and grinding work
- Material weight 470 gram/m<sup>2</sup>



► **APOLLO WELDING BLANKET**

Apollo width 100 cm, full rol 50 m <sup>1</sup>	56.50.02.1050
---	---------------

**A2, s1, d0 EN 13501-1 approved non-flammable**

- Fibreglass cloth (filament)
- 1 sided PU-coating
- Temperature resistance 550°C
- Peak temperature approx. 600°C
- Light welding and grinding work
- Material weight 460 gram/m<sup>2</sup>



► **CETO 2 WELDING BLANKET**

Ceto width 100 cm, full rol 25 m <sup>1</sup>	56.52.06.1025
---	---------------

- Fibreglass cloth (filament)
- 2-sided silicone rubber coating
- Temperature resistance 550°C
- Peak temperature approx. 600°C
- Oil, grease and acid resistant
- Material weight 590 gram/m<sup>2</sup>



**CONDITIONS CUSTOM-MADE WELDING BLANKETS**

The specifications for custom-made welding blankets are:

- Sewn on the cut edges.
- Minimum size available is 1m<sup>2</sup>.
- Maximum size available is 15m<sup>2</sup>.
- The minimum length per side is 100 cm.
- Welding blankets are made with 5 cm tolerance on the provided measurements
- Custom-made welding blankets are not returnable

► **CEPRO SATURN WELDING BLANKETS**

- Made from non-woven carbon felt
- Suitable for high temperatures
- Very flexible
- Scratch-free
- Light-weight
- Not suitable as cooling down blanket

Saturn is perfect to be put to use as an all round welding blanket, for example in the field of :

- Machine building and maintenance.
- Cutting and grinding work
- Ship maintenance
- Automotive industries

Saturn welding blankets have a very high peak temperature (1300 °C) and are relatively light-weight. Furthermore, Saturn welding blankets are very flexible and can be used in small spaces and in odd corners.

► **SATURN 420 WELDING BLANKET**

Saturn 420 welding blanket 200 x 100 cm	56.57.12
Saturn 420 welding blanket 200 x 200 cm	56.57.15
Saturn 420 welding blanket 200 x 300 cm	56.57.16

Saturn 420 width 200 cm, roll length 50 m	56.57.01.2050
Saturn 420 width 200 cm, roll length 10 m	56.57.01.2010
Saturn 420 width 200 cm, part of a rol	56.57.01.2000

- Carbon felt
- Temperature resistance 1300°C
- Suitable for welding and grinding
- Very flexible
- Scratch-free
- Material weight 420 gram/m<sup>2</sup>



**CEPRO SATURN WELDING BLANKETS**



Saturn blankets are very suitable for use in the automotive industry.



► **CEPRO SPECIAL BLANKETS**

► **PROTECTION COVERS**

Protection cover 200 x 200 cm incl. 10 magnets, 690 gram/m <sup>2</sup>	59.06.00.0007
Protection cover 180 x 200 cm 1,220 gram/m <sup>2</sup>	56.50.95

- Suitable for maintenance to cars and trucks.



► **DOORSLEEVE**

Door sleeve 150 x 125 cm 690 gram/m <sup>2</sup>	59.06.00.0001
---	---------------

- Suitable for cars and trucks.
- Glass fibre (filament)
- 1 side PU coating
- Temperature resistance 550 °C
- Material weight 690 gram/m<sup>2</sup>.



► **BLANKET ACCESSORIES**

► **BRASS EYELETS Ø 12 MM**

Brass eyelets, pressed into the fabric	50.01.10
--	----------



► **VELCRO, WIDTH 25 MM**

Velcro, hook part, stitched with Kevlar	50.05.20.9910
Velcro, hook part, self adhesive	50.05.20.0010
Velcro, loop part, stitched with Kevlar	50.05.20.9920
Velcro, loop part, self adhesive	50.05.20.0020



► **MAGNETS Ø 45 MM**

Magnets, seamed into fabric Ø 45 mm, thickness 9 mm	50.10.09.0045
--	---------------



► **CEPRO INSULATION PRODUCTS**

- Controlled cooling of hot objects to improve quality of the weld
- Prevention of injuries due to contact with hot objects
- Made from high-quality materials

► **CEPRO WELDING CUSHION**

±48 x ±48 cm, thickness 8 cm,  
filled with glass needle mats 57.51.10.05

±100 x ±98 cm, thickness 8 cm,  
filled with glass needle mats 57.51.10.10



► **CEPRO INSULATION SLEEVES**

±100 x ±48 cm, for outside pipe diameters  
from 15 to max. 28 cm 57.50.10.11

±150 x ±48 cm, for outside pipe diameters  
from 29 to max. 44 cm 57.50.10.12

±200 x ±48 cm, for outside pipe diameters  
from 45 to max. 61 cm 57.50.10.13



► **CEPRO INSULATION BLANKETS**

±98 x ±200 cm, thickness 3 cm 57.50.23.10

±200 x ±196 cm, thickness 3 cm 57.50.23.20

±98 x ±200 cm, thickness 6 cm 57.50.26.10

±200 x ±196 cm, thickness 6 cm 57.50.26.20

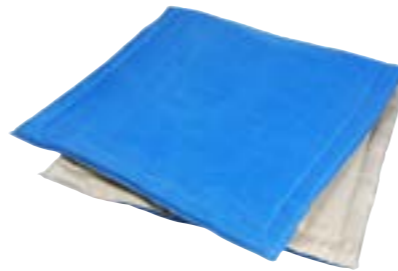

► **CEPRO GRINDING CURTAINS 140CM WIDE**

- Standard width 140 cm
- Fully seamed all-around
- 7 eyelets on one side measuring 140 cm
- Snap-fasteners on both sides
- Including 7 free steel suspension rings

► **CEPRO CLEAR GRINDING CURTAINS 140CM WIDE - B2 QUALITY**

H. 160 cm x 140 cm	16.10.16	
H. 180 cm x 140 cm	16.10.18	
H. 200 cm x 140 cm	16.10.20	
H. 220 cm x 140 cm	16.10.22	
H. 240 cm x 140 cm	16.10.24	
H. 260 cm x 140 cm	16.10.26	
H. 280 cm x 140 cm	16.10.28	
H. 300 cm x 140 cm	16.10.30	
Custom-made > 10m <sup>2</sup>	16.10.99	
Custom-made < 10m <sup>2</sup>	16.10.99	on demand

**DIN 4102 - B2  
APPROVED**



► **CEPRO CLEAR GRINDING CURTAINS 140CM WIDE - B1 QUALITY**

H. 160 cm x 140 cm	16.30.16	
H. 180 cm x 140 cm	16.30.18	
H. 200 cm x 140 cm	16.30.20	
H. 220 cm x 140 cm	16.30.22	
H. 240 cm x 140 cm	16.30.24	
H. 260 cm x 140 cm	16.30.26	
H. 280 cm x 140 cm	16.30.28	
H. 300 cm x 140 cm	16.30.30	
Custom-made > 10m <sup>2</sup>	16.30.99	
Custom-made < 10m <sup>2</sup>	16.30.99	on demand

**DIN 4102 - B1  
APPROVED**



**CEPRO INDUSTRIAL CURTAINS**

CEPRO Industrial Curtains provide excellent protection against all kinds of industrial nuisance. They are available in various colours and with or without a see through window .

Please contact our sales department for more information about our industrial protection items .

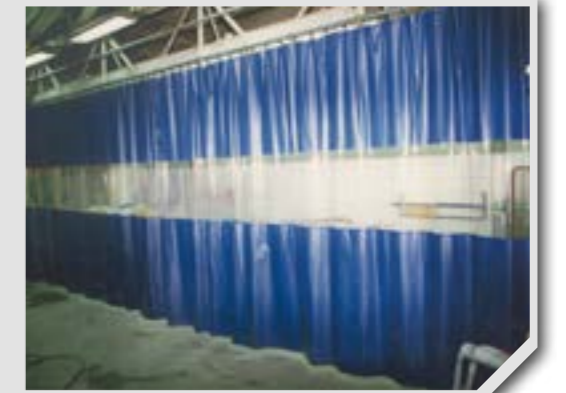

► **CEPRO GRINDING STRIPS**

- Widths 200, 300 and 400 mm wide
- Thicknesses 2, 3 and 4 mm
- Full roll 50 metres
- Available cut and punched
- Suspension with plastic suspension clip

► **CEPRO GRINDING STRIPS - B2 QUALITY**

200 x 2 mm uncut per meter	26.20.22	<b>DIN 4102 - B2 APPROVED</b>
300 x 2 mm uncut per meter	26.20.02	
300 x 3 mm uncut per meter	26.20.03	
400 x 4 mm uncut per meter	26.20.44	
300 x 2 mm cut to size and punched according to the CEPRO pattern minimum length 150 cm	26.20.02.91	
300 x 3 mm cut to size and punched according to the CEPRO pattern minimum length 150 cm	26.20.03.91	



► **CEPRO GRINDING STRIPS FULL ROLLS - B2 QUALITY**

200 x 2 mm per full roll of 50 m	26.20.22.0050
300 x 2 mm per full roll of 50 m	26.20.02.0050
300 x 3 mm per full roll of 50 m	26.20.03.0050
400 x 4 mm per full roll of 50 m	26.20.44.0050

**DIN 4102 - B2  
APPROVED**



► **CEPRO GRINDING STRIPS FULL ROLLS - B1 QUALITY**

200 x 2 mm per full roll of 50 m	26.30.22.0050
300 x 2 mm per full roll of 50 m	26.30.02.0050
300 x 3 mm per full roll of 50 m	26.30.03.0050
400 x 4 mm per full roll of 50 m	26.30.44.0050

**DIN 4102 - B1  
APPROVED**



**CEPRO CLEAR STRIPS**



CEPRO Clear colourless transparent strips can also be used as protection from all kinds of external factors such as draughts, moisture, dust, cold, air, noise etc.

Please contact our sales department for a quotation.



► **CEPRO SUSPENSION CLIPS**

- Easy assembly of welding strips
- Suitable for overlap of 5 and 10 cm
- Easy to unfold using folding line

► **CEPRO STANDARD SUSPENSION CLIP 20 CM**

Standard clip 20 cm 20.11.01

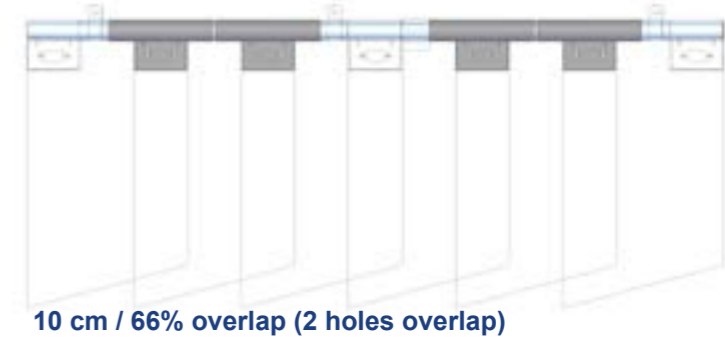

10 cm / 66% overlap (2 holes overlap)

► **CEPRO SQUARE SUSPENSION CLIP 10 CM**

Square clip 10 cm 20.11.09

Suspension clip to be used as initial clip in a separation or next to a support.

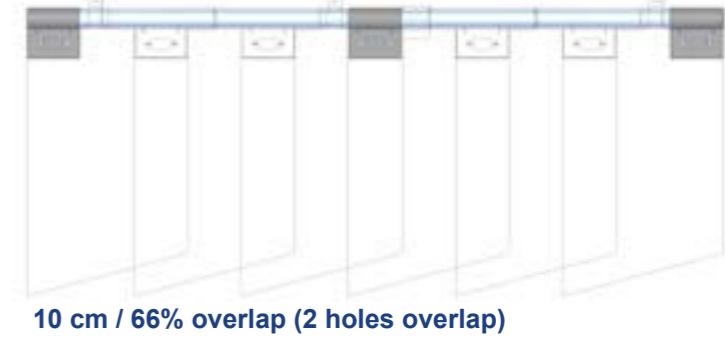

10 cm / 66% overlap (2 holes overlap)

► **CEPRO FILLING PIECE 5 CM**

Filling piece 5 cm 20.11.90

Filling piece, for overlap of 5cm or next to a support in combination with a square clip.



10 cm / 66% overlap (2 holes overlap)

5 cm / 33% overlap (1 hole overlap)



**MOUNTING STRIPS**



For mounting instructions for Cepro strip separation, please see page 14.

If you have any questions or if you are in need of a quotation please contact our sales department.





**WELDING SCREENS**

The main dangers of unprotected exposure to welding light are: arc eye (during short-term exposure), cataract (by prolonged exposure) and skin burn. The latter can also lead to skin cancer. The welder protects himself by wearing a welding mask and protective clothing but bystanders are exposed to the same dangers. This is why it is important to protect bystanders in the work place to prevent long-term illness.

When protecting the welding area, it is important not to isolate it from other work areas which is one of the reasons why a welding curtain should be made of transparent material. This not only helps to keep an overview of the work progress, but also allows for a quick response in the case of emergencies. It also prevents the welder from suffering from claustrophobia.

In addition to a wide-range of other products, CEPRO can also provide the necessary materials to construct a welding booth as a non-permanent fixture.

We can also supply a mobile welding booth which is suitable and easier to move to different locations. Not only do these booths provide protection but they also offer flexibility for organizing workspace. They provide an optimal solution because they can be quickly dismantled and removed from the work floor when welding work is not being carried out.

**Certification**

All CEPRO products used in our welding screens have been approved according to the European EN ISO 25980 standard and are regularly retested and re-certified. Therefore customers are always assured of obtaining a safe product.

**Available products**

The CEPRO welding screens programme is divided into 3 product groups which are suitable for various applications.

- **CEPRO Robusto welding screens**  
Very high quality screens. Because they are solidly built they can be used in even the most demanding working conditions.
- **CEPRO Omnium welding screens**  
Sturdy and stylish screens. The CEPRO Omnium welding screen is an all-round welding screen and often used in difficult working conditions.
- **CEPRO Gazelle welding screens**  
Ideal for use in smaller workspaces and infrequent use. They are very lightweight and can be easily moved by hand.

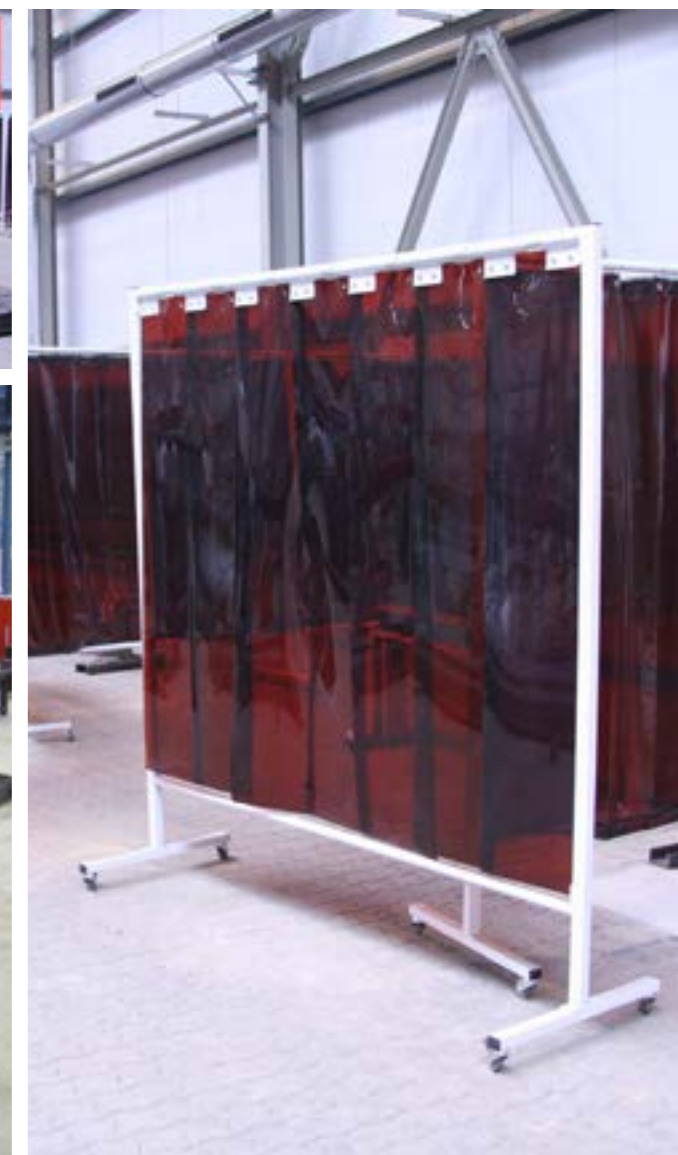

▶ **CEPRO ROBUSTO WELDING SCREEN 215 CM**

- Height 210 cm
- Width central section 215 cm
- Standard 4 swivel castors Ø 75 mm
- 2 swivel castors with brake and 2 without
- RAL 7035 powder coating finish
- Round 35 x 2.5 mm tube
- Rectangular 50 x 30 x 2 mm tube

▶ **CEPRO ROBUSTO TRIPTYCH WELDING SCREEN 355 CM**

- Height 210 cm
- Width central section 215 cm
- 2 swivel arms each 70 cm
- Standard 4 swivel castors Ø 75 mm
- 2 swivel castors with brake and 2 without
- RAL 7035 powder coating finish
- Round 35 x 2.5 mm tube
- Rectangular 50 x 30 x 2mm tube

▶ **CEPRO ROBUSTO WELDING SCREEN 215 CM - WITH WELDING CURTAIN**

Cepro Orange Transparent	36.32.15
Cepro Dark Green non-transparent	36.32.19
Cepro Green Transparent	36.32.16
Cepro Bronze Transparent	36.32.17

- Curtain height 180 cm
- Ground clearance 15 cm
- Plastic suspension rings
- Curtains EN ISO 25980 approved

**EN ISO 25980  
APPROVED**



▶ **CEPRO ROBUSTO TRIPTYCH WELDING SCREEN 355 CM - WITH WELDING CURTAINS**

Cepro Orange Transparent	36.31.15
Cepro Dark Green non-transparent	36.31.19
Cepro Green Transparent	36.31.16
Cepro Bronze Transparent	36.31.17

- Curtain height 180 cm
- Ground clearance 15 cm
- Plastic suspension rings
- Curtains EN ISO 25980 approved

**EN ISO 25980  
APPROVED**



▶ **CEPRO ROBUSTO WELDING SCREEN 215 CM - WITH WELDING STRIPS**

Cepro Orange Transparent	36.32.25
Cepro Dark Green non-transparent	36.32.29
Cepro Green Transparent	36.32.26
Cepro Bronze Transparent	36.32.27

- Strips height 180 cm
- Ground clearance 15 cm
- Strips 300 x 2 mm
- Overlap strips 10 cm
- Plastic suspension clips
- Strips EN ISO 25980 approved

**EN ISO 25980  
APPROVED**



▶ **CEPRO ROBUSTO TRIPTYCH WELDING SCREEN 355 CM - WITH WELDING STRIPS**

Cepro Orange Transparent	36.31.25
Cepro Dark Green non-transparent	36.31.29
Cepro Green Transparent	36.31.26
Cepro Bronze Transparent	36.31.27

- Strips height 180 cm
- Ground clearance 15 cm
- Strips 300 x 2 mm
- Overlap strips 10 cm
- Plastic suspension clips
- Strips EN ISO 25980 approved

**EN ISO 25980  
APPROVED**



▶ **CEPRO ROBUSTO WELDING SCREEN 215 CM - SPECIALS**

Cepro Atlas heat resistant curtain	36.32.31
With Cepro Sonic sound absorbing curtain	36.32.45

- Curtain height 180 cm
- Ground clearance 15 cm
- Atlas curtain 550 °C - A2 - EN 13501-1 approved
- Sonic curtain Rw= 14 dB



▶ **CEPRO ROBUSTO TRIPTYCH WELDING SCREEN 355 CM - SPECIALS**

Cepro Atlas heat resistant curtain	36.31.31
Cepro Sonic sound absorbing curtain	36.31.45

- Curtain height 180 cm
- Atlas curtain 550 °C - A2 - EN 13501-1 approved
- Sonic curtain Rw= 14 dB



▶ **REPLACEMENT FILLING FOR CEPRO ROBUSTO SINGLE SCREEN 215 CM**

Cepro Orange Transparent replacement curtain	18.15.18	Cepro Orange Transparent replacement strips	29.05.18.0010
Cepro Dark Green non-transparent replacement curtain	18.19.18	Cepro Dark Green non-transparent replacement strips	29.09.18.0010
Cepro Green Transparent replacement curtain	18.16.18	Cepro Green Transparent replacement strips	29.06.18.0010
Cepro Bronze Transparent replacement curtain	18.17.18	Cepro Bronze Transparent replacement strips	29.07.18.0010
Cepro Atlas replacement curtain	59.01.10.0003	Cepro Sonic replacement curtain	92.15.01 <b>on demand</b>

▶ **REPLACEMENT FILLING FOR CEPRO ROBUSTO TRIPTYCH SCREEN 355 CM**

Cepro Orange Transparent replacement curtain	18.15.18.0001	Cepro Orange Transparent replacement strips	29.05.18.0016
Cepro Dark Green non-transparent replacement curtain	18.19.18.0001	Cepro Dark Green non-transparent replacement strips	29.09.18.0016
Cepro Green Transparent replacement curtain	18.16.18.0001	Cepro Green Transparent replacement strips	29.06.18.0016
Cepro Bronze Transparent replacement curtain	18.17.18.0001	Cepro Bronze Transparent replacement strips	29.07.18.0016
Cepro Atlas replacement curtain	59.01.10.0004	Cepro Sonic replacement curtain	92.15.01 <b>on demand</b>

► **CEPRO ROBUSTO TRIPTYCH XL WELDING SCREEN 435CM**

- Height 210 cm
- Width central section 215 cm
- 2 swivel arms each 110 cm
- Standard 4 swivel castors Ø 75 mm
- 2 swivel castors with brake and 2 without
- RAL 7035 powder coating finish
- Round 35 x 2.5 mm tube
- Rectangular 50 x 30 x 2 mm tube

► **CEPRO ROBUSTO TRIPTYCH XL WELDING SCREEN 435 CM - WITH WELDING CURTAINS**

Cepro Orange Transparent	36.31.65
Cepro Dark Green non-transparent	36.31.69
Cepro Green Transparent	36.31.66
Cepro Bronze Transparent	36.31.67

- Curtain height 180 cm
- Ground clearance 15 cm
- Plastic suspension rings
- Curtains EN ISO 25980 approved

**EN ISO 25980  
APPROVED**



► **CEPRO ROBUSTO TRIPTYCH XL WELDING SCREEN 435 CM - WITH WELDING STRIPS**

Cepro Orange Transparent	36.31.75
Cepro Dark Green non-transparent	36.31.79
Cepro Green Transparent	36.31.76
Cepro Bronze Transparent	36.31.77

- Strips height 180 cm
- Ground clearance 15 cm
- Strips 300 x 2mm
- Overlap strips 10cm
- Plastic suspension clips
- Strips EN ISO 25980 approved

**EN ISO 25980  
APPROVED**



► **CEPRO ROBUSTO TRIPTYCH XL WELDING SCREEN 435 CM - SPECIALS**

Cepro Atlas heat resistant curtain	36.31.81
Cepro Sonic sound absorbing curtain	36.31.95

- Curtain height 180 cm
- Ground clearance 15 cm
- Atlas curtain 550 °C - A2 - EN 13501-1 approved
- Sonic curtain Rw= 14 dB



► **REPLACEMENT FILLING FOR CEPRO ROBUSTO TRIPTYCH XL WELDING SCREEN**

Cepro Orange Transparent replacement curtain	18.15.18.0002	Cepro Orange Transparent replacement strips	29.05.18.0020
Cepro Dark Green non-transparent replacement curtain	18.19.18.0002	Cepro Dark Green non-transparent replacement strips	29.09.18.0020
Cepro Green Transparent replacement curtain	18.16.18.0002	Cepro Green Transparent replacement strips	29.06.18.0020
Cepro Bronze Transparent replacement curtain	18.17.18.0002	Cepro Bronze Transparent replacement strips	29.07.18.0020
Cepro Atlas replacement curtain	59.01.10.0005	Cepro Sonic replacement curtain	92.15.01 on demand

► **CEPRO ROBUSTO ACCESSOIRES**

- Parts for Robusto screen
- Castors Ø 75 mm
- Round 35 x 2,5 mm tube

► **CEPRO ROBUSTO CASTORS**

Castors for Robusto screen  
with break Ø 75 mm 30.04.32.01

Castors for Robusto screen  
without break Ø 75 mm 30.04.32.00



► **CEPRO ROBUSTO SWIVEL ARM 70 CM**

Without curtains/strips	30.01.32.07
Cepro Orange Transparent curtain	30.01.32.0715
Cepro Dark Green non-transparent curtain	30.01.32.0719
Cepro Green Transparent curtain	30.01.32.0716
Cepro Bronze Transparent curtain	30.01.32.0717

Without curtains/strips	30.01.32.07
Cepro Orange Transparent strips	30.01.32.0725
Cepro Dark Green non-transparent strips	30.01.32.0729
Cepro Green Transparent strips	30.01.32.0726
Cepro Bronze Transparent strips	30.01.32.0727

► **CEPRO ROBUSTO SWIVEL ARM 110 CM**

Without curtains/strips	30.01.32.11
Cepro Orange Transparent curtain	30.01.32.1115
Cepro Dark Green non-transparent curtain	30.01.32.1119
Cepro Green Transparent curtain	30.01.32.1116
Cepro Bronze Transparent curtain	30.01.32.1117

Without curtains/strips	30.01.32.11
Cepro Orange Transparent strips	30.01.32.1125
Cepro Dark Green non-transparent strips	30.01.32.1129
Cepro Green Transparent strips	30.01.32.1126
Cepro Bronze Transparent strips	30.01.32.1127

► **CEPRO ROBUSTO SPECIAL HINGE FOR SWIVEL ARM**

Special additional hinge-point for Robusto screen  
30.01.32

- Suitable for positioning swivel  
arm parallel to the screen.

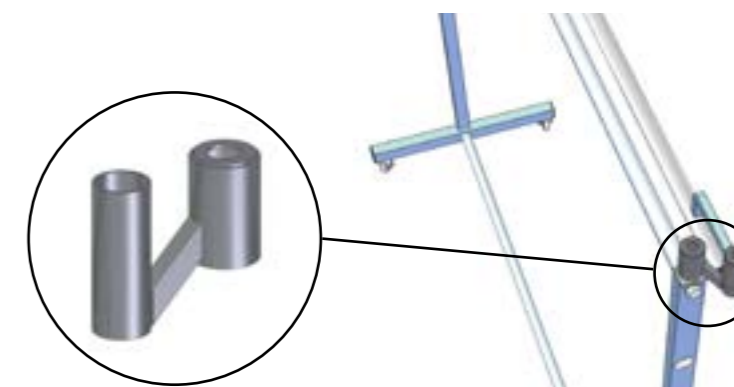

**▶ CEPRO OMNIUM WELDING SCREEN 215 CM**

- Height 200 cm
- Width central section 215 cm
- Standard 4 swivel castors Ø 50 mm
- 2 swivel castors with brake and 2 without
- RAL 7035 powder coating finish
- Round 30 x 2 mm tube
- Rectangular 40 x 30 x 2 mm tube

**▶ CEPRO OMNIUM TRIPTYCH WELDING SCREEN 375 CM**

- Height 200 cm
- Width central section 215cm
- 2 swivel arms each 80cm
- Standard 4 swivel castors Ø 50mm
- 2 swivel castors with brake and 2 without
- RAL 7035 powder coating finish
- Round 30 x 2 mm tube
- Rectangular 40 x 30 x 2 mm tube

**▶ CEPRO OMNIUM WELDING SCREEN 215 CM - WITH WELDING CURTAIN**

Cepro Orange Transparent	36.34.15
Cepro Dark Green non-transparent	36.34.19
Cepro Green Transparent	36.34.16
Cepro Bronze Transparent	36.34.17

- Curtain height 160 cm
- Ground clearance 30 cm
- Plastic suspension rings
- Curtains EN ISO 25980 approved

**EN ISO 25980 APPROVED**



**▶ CEPRO OMNIUM TRIPTYCH WELDING SCREEN 375 CM - WITH WELDING CURTAINS**

Cepro Orange Transparent	36.36.15
Cepro Dark Green non-transparent	36.36.19
Cepro Green Transparent	36.36.16
Cepro Bronze Transparent	36.36.17

- Curtain height 160 cm
- Ground clearance 30 cm
- Plastic suspension rings
- Curtains EN ISO 25980 approved

**EN ISO 25980 APPROVED**



**▶ CEPRO OMNIUM WELDING SCREEN 215 CM - WITH WELDING STRIPS**

Cepro Orange Transparent	36.34.25
Cepro Dark Green non-transparent	36.34.29
Cepro Green Transparent	36.34.26
Cepro Bronze Transparent	36.34.27

- Strip height 160 cm
- Ground clearance 30 cm
- Strips 300 x 2 mm
- Overlap strips 5 cm
- Plastic suspension clips
- Strips EN ISO 25980 approved

**EN ISO 25980 APPROVED**



**▶ CEPRO OMNIUM TRIPTYCH WELDING SCREEN 375 CM - WITH WELDING STRIPS**

Cepro Orange Transparent	36.36.25
Cepro Dark Green non-transparent	36.36.29
Cepro Green Transparent	36.36.26
Cepro Bronze Transparent	36.36.27

- Strips height 160 cm
- Ground clearance 30 cm
- Strips 300 x 2 mm
- Overlap strips 5 cm
- Plastic suspension clips
- Strips EN ISO 25980 approved

**EN ISO 25980 APPROVED**



**▶ CEPRO OMNIUM WELDING SCREEN 215 CM - WITH WELDING SHEET**

Cepro Orange Transparent	36.34.05
Cepro Dark Green non-transparent	36.34.09
Cepro Green Transparent	36.34.06
Cepro Bronze Transparent	36.34.07

- Sheet height 160 cm
- Ground clearance 30 cm
- Sheets 570 x 1 mm
- Metal tube clamps
- Sheet EN ISO 25980 approved

**EN ISO 25980 APPROVED**



**▶ CEPRO OMNIUM TRIPTYCH WELDING SCREEN 375 CM - WITH WELDING SHEET**

Cepro Orange Transparent	36.36.05
Cepro Dark Green non-transparent	36.36.09
Cepro Green Transparent	36.36.06
Cepro Bronze Transparent	36.36.07

- Sheet height 160 cm
- Ground clearance 30 cm
- Sheets 570 x 1 mm
- Metal tube clamps
- Sheet EN ISO 25980 approved

**EN ISO 25980 APPROVED**



**▶ REPLACEMENT FILLING FOR CEPRO OMNIUM SINGLE SCREEN 215 CM**

Cepro Orange Transparent replacement curtain 18.15.16	Cepro Orange Transparent replacement strips 29.05.16.0008	Cepro Orange Transparent replacement sheet 22.15.16.0004
Cepro Dark Green non-transparent replacement curtain 18.19.16	Cepro Dark Green non-transparent replacement strips 29.09.16.0008	Cepro Dark Green non-transparent replacement sheet 22.19.16.0004
Cepro Green Transparent replacement curtain 18.16.16	Cepro Green Transparent replacement strips 29.06.16.0008	Cepro Green Transparent replacement sheet 22.16.16.0004
Cepro Bronze Transparent replacement curtain 18.17.16	Cepro Bronze Transparent replacement strips 29.07.16.0008	Cepro Bronze Transparent replacement sheet 22.17.16.0004

**▶ REPLACEMENT FILLING FOR CEPRO OMNIUM TRIPTYCH SCREEN 375 CM**

Cepro Orange Transparent replacement curtain 18.15.16.0001	Cepro Orange Transparent replacement strips 29.05.16.0014	Cepro Orange Transparent replacement sheet 2 x 22.15.16.0004
Cepro Dark Green non-transparent replacement curtain 18.19.16.0001	Cepro Dark Green non-transparent replacement strips 29.09.16.0014	Cepro Dark Green non-transparent replacement sheet 2 x 22.19.16.0004
Cepro Green Transparent replacement curtain 18.16.16.0001	Cepro Green Transparent replacement strips 29.06.16.0014	Cepro Green Transparent replacement sheet 2 x 22.16.16.0004
Cepro Bronze Transparent replacement curtain 18.17.16.0001	Cepro Bronze Transparent replacement strips 29.07.16.0014	Cepro Bronze Transparent replacement sheet 2 x 22.17.16.0004

► **CEPRO OMNIUM TRIPTYCH XL WELDING SCREEN 435 CM**

- Height 200 cm
- Width central section 215 cm
- 2 swivel arms each 110 cm
- Standard 4 swivel castors Ø 50 mm
- 2 swivel castors with brake and 2 without
- RAL 7035 powder coating finish
- Round 30 x 2 mm tube
- Rectangular 40 x 30 x 2 mm tube

► **CEPRO OMNIUM TRIPTYCH XL WELDING SCREEN 435CM - WITH WELDING CURTAINS**

Cepro Orange Transparent	36.36.65
Cepro Dark Green non-transparent	36.36.69
Cepro Green Transparent	36.36.66
Cepro Bronze Transparent	36.36.67

- Curtain height 160 cm
- Ground clearance 30 cm
- Plastic suspension rings
- Curtains EN ISO 25980 approved

**EN ISO 25980  
APPROVED**



► **REPLACEMENT CURTAIN FOR CEPRO OMNIUM TRIPTYCH XL SCREEN 435CM**

Cepro Orange Transparent	18.15.16.0002
Cepro Dark Green non-transparent	18.19.16.0002
Cepro Green Transparent	18.16.16.0002
Cepro Bronze Transparent	18.17.16.0002

- Curtain height 160 cm
- Curtains EN ISO 25980 approved

**EN ISO 25980  
APPROVED**



► **CEPRO OMNIUM ACCESSOIRES**

- Parts for Omnium screen
- Castors Ø 50 mm
- Round 30 x 2 mm tube

► **CEPRO OMNIUM CASTORS**

Castors for Omnium screen  
with break Ø 50 mm 30.04.34.01

Castors for Omnium screen  
without break Ø 50 mm 30.04.34.00



► **CEPRO OMNIUM SWIVEL ARM 80CM**

Without curtains/strips	30.01.34.08
Cepro Orange Transparent curtain	30.01.34.0815
Cepro Dark Green non-transparent curtain	30.01.34.0819
Cepro Green Transparent curtain	30.01.34.0816
Cepro Bronze Transparent curtain	30.01.34.0817

Without curtains/strips	30.01.34.08
Cepro Orange Transparent strips	30.01.34.0825
Cepro Dark Green non-transparent strips	30.01.34.0829
Cepro Green Transparent strips	30.01.34.0826
Cepro Bronze Transparent strips	30.01.34.0827

► **CEPRO OMNIUM SWIVEL ARM 110CM**

Without curtains	30.01.32.11
Cepro Orange Transparent curtain	30.01.34.1115
Cepro Dark Green non-transparent curtain	30.01.34.1119
Cepro Green Transparent curtain	30.01.34.1116
Cepro Bronze Transparent curtain	30.01.34.1117

► **CEPRO OMNIUM SPECIAL HINGE FOR SWIVEL ARM**

Special additional hinge-point for Omnium screen  
30.01.32

- Suitable for positioning swivel arm parallel to the screen.

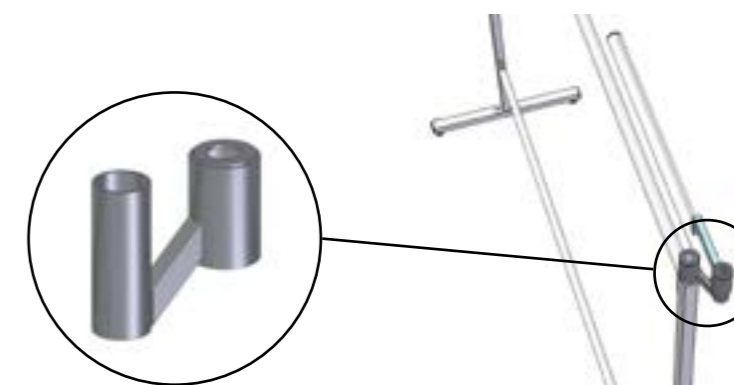

**PRODUCT FACT SHEETS**

**i** For all welding screens product fact sheets are available with information about dimensions, mounting etc.

Please visit our website or contact our sales department for more information.



**CEPRO GAZELLE WELDING SCREEN**

- Height 200 cm
- Width 200 cm / 140 cm
- Without castors
- Galvanized frame
- Round 25 x 1 mm tube
- Fitted with a curtain with an open seam on the top and bottom

**CEPRO GAZELLE WELDING SCREEN 140CM**

Cepro Orange Transparent	36.39.15
Cepro Dark Green non-transparent	36.39.19
Cepro Green Transparent	36.39.16
Cepro Bronze Transparent	36.39.17

- Curtain height 176 cm
- Ground clearance 30 cm
- Weight 8,75 kg
- Fitted curtain with an open seam at the top and bottom
- Curtain EN ISO 25980 approved

**EN ISO 25980  
APPROVED**



**CEPRO GAZELLE WELDING SCREEN 200CM**

Cepro Orange Transparent	36.39.25
Cepro Dark Green non-transparent	36.39.29
Cepro Green Transparent	36.39.26
Cepro Bronze Transparent	36.39.27

- Curtain height 176 cm
- Ground clearance 30 cm
- Weight 8,75 kg
- Fitted curtain with an open seam at the top and bottom
- Curtain EN ISO 25980 approved

**EN ISO 25980  
APPROVED**



**REPLACEMENT CURTAINS FOR CEPRO GAZELLE WELDING SCREEN**

Cepro Orange Transparent 140 cm wide	13.15.04.14	Cepro Orange Transparent 200 cm wide	13.15.04.20
Cepro Dark Green non-transparent 140 cm wide	13.19.04.14	Cepro Dark Green non-transparent 200 cm wide	13.19.04.20
Cepro Green Transparent 140 cm wide	13.16.04.14	Cepro Green Transparent 200 cm wide	13.16.04.20
Cepro Bronze Transparent 140 cm wide	13.17.04.14	Cepro Bronze Transparent 200 cm wide	13.17.04.20



**CEPRO GAZELLE WELDING SCREEN**

**i** The Gazelle welding screen is designed for use in small workplaces or when the use is not very frequent. When work needs to be regularly done in different places or when flexibility in the organization of the working space is required, protection with movable screens can offer a better alternative.

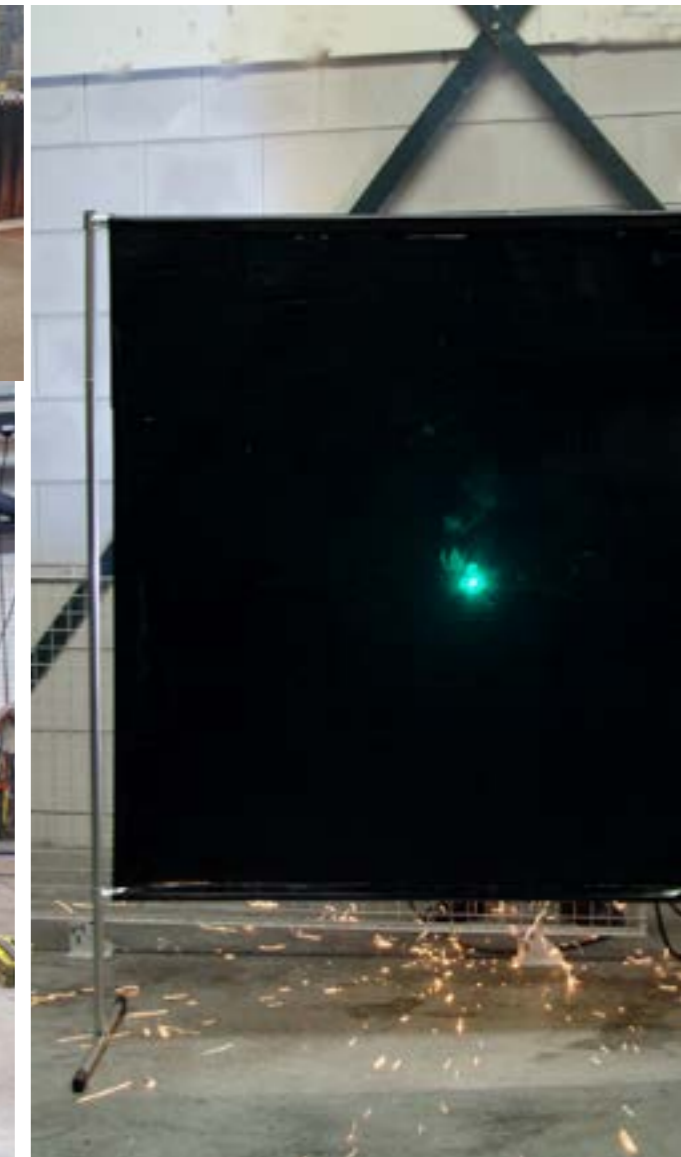
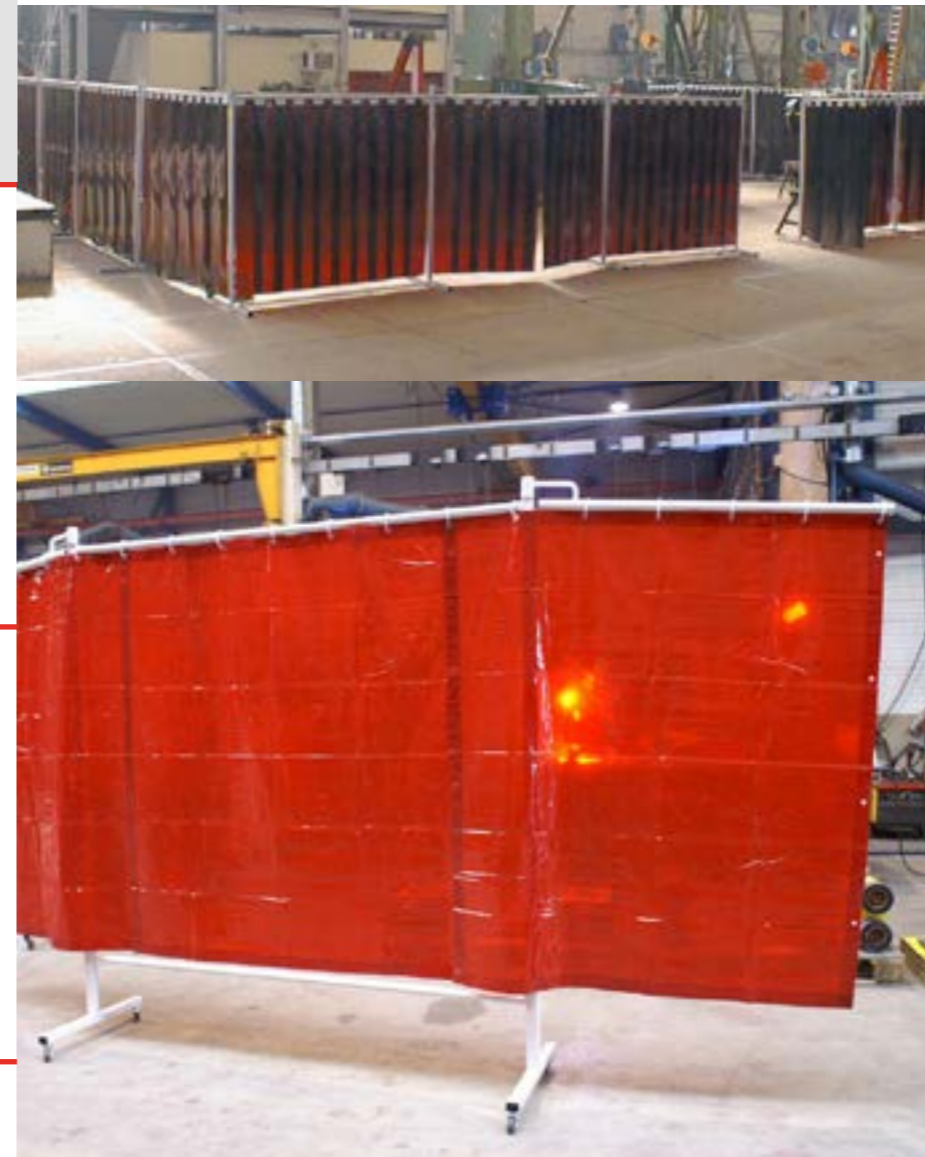

**▶ SONIC CLASSIC**

Welding and grinding operations are one of the most important noise sources in industrial working environments. Prolonged exposure to high noise concentrations can damage ear drums and cause noise-related deafness. Besides personal suffering, this often means long term absences through illness or high costs as a result of permanent disability. In less serious cases, too much noise is often the cause of loss of concentration and consequently loss of quality and lower production volumes.

The unique, compact construction of the CEPRO SONIC wall system with built-in soundproof elements not only produces sound attenuation but also effective noise reduction in the rest of the working environment. The modular system can be easily and quickly assembled (and is therefore cost-reducing), moved, expanded or changed into another configuration. The CEPRO SONIC wall system exceeds the quality and effectiveness of all other branded systems of its competitors.

**▶ Certification**

All CEPRO soundproof SONIC products were extensively tested by internationally reputed testing organisations. Measurement statistics of all tests are available. The flame extinction properties of these products were also tested where necessary.

**▶ Available models**

- CEPRO Sonic Classic wall elements for building up a welding booth
- CEPRO Sonic Classic accessories, for further expanding your welding booth
- CEPRO Sonic Classic supports, to complete your welding booth
- CEPRO Sonic Classic grinding booths, fitted with sound absorbing roof.

**▶ Made to size**

CEPRO can also offer you tailor made and constructed installations. This goes for dimensions, design and colour scheme. You can count on receiving professional advice from one of our advisors. Please contact our sales department to make an appointment.

**▶ Projects**

CEPRO is a specialist in solutions for specific problems which occur in the welding and grinding work area. Sometimes these problems are isolated problems but mostly they are combinations and are part of an overall safety policy. CEPRO knows more than anybody else how to optimally combine the properties of its different products with those of others into a pleasant workplace which meets all safety and efficiency requirements. During the optimisation of a workplace we are in many cases also confronted with other issues which are important such as concerns about the evacuation of harmful welding gases, the supply of gas and oxygen, air conditioning, communication systems or even the most efficient way of supplying electricity to the workplace.

Many entrepreneurs therefore consider the involvement of CEPRO an ideal opportunity to optimise workplaces, straighten out logistics and workflow and upgrade general and technical aspects.



► **CEPRO SONIC CLASSIC WALL ELEMENTS**

- Height 2,012 mm
- Width 1,012 or 512 mm
- Thickness 50 mm
- Standard ± 180 mm free space at the bottom
- Finish in powdercoating

► **CEPRO SONIC SOUND INSULATING WALL ELEMENT**

Sonic Classic wall element 1,012 mm  
Width 1,012 mm  
Height 2,012 mm  
Thickness 50 mm

In green RAL 6011 45.00.00.2010  
In grey RAL 7035 45.00.10.2010



► **CEPRO SONIC SOUND INSULATING WALL ELEMENT**

Sonic Classic wall element 512 mm  
Width 512 mm  
Height 2,012 mm  
Thickness 50 mm

In green RAL 6011 45.00.00.2005  
In grey RAL 7035 45.00.10.2005

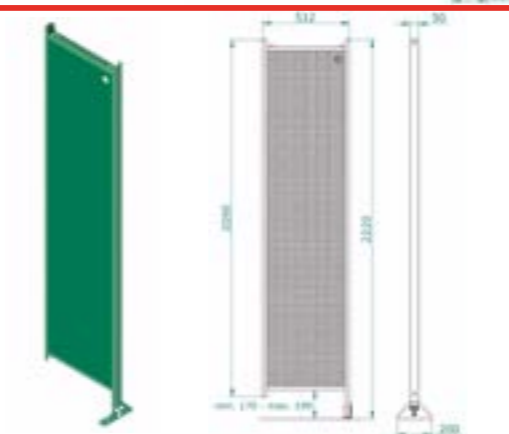

► **CEPRO SONIC SOUND INSULATING WALL ELEMENT**

Sonic Classic wall element with Impact Bronze window  
Width 1,012 mm  
Height 2,012 mm  
Thickness 50 mm

In green RAL 6011 45.00.03.2010  
In grey RAL 7035 45.00.13.2010

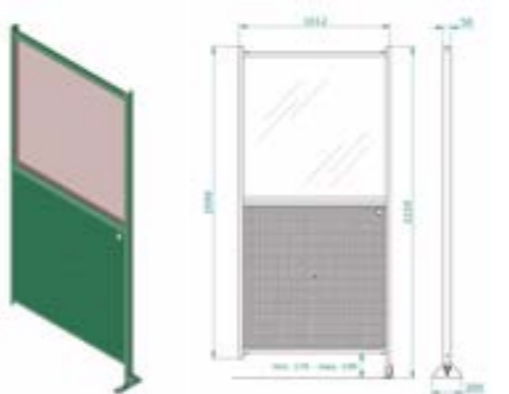

► **CEPRO SONIC CONNECTING POLES**

Sonic joining pole height 2,090 mm  
For connecting Sonic wall elements in an angle of 90° or as a cross bond. Made from square tube 50 x 50 mm,  
In green RAL 6011 45.20.01  
In grey RAL 7035 45.20.11

Sonic joining pole extra long,  
for mounting fume extraction arm.  
45.30.15.0001

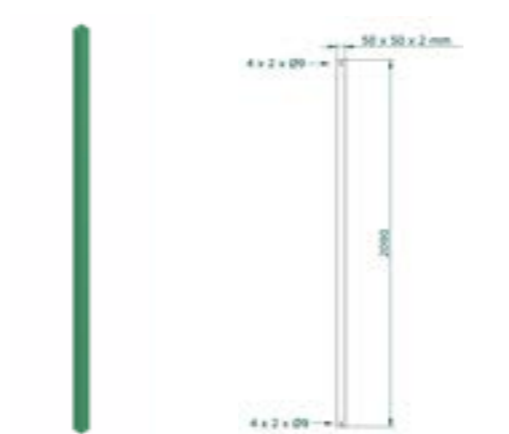

► **CEPRO SONIC CLASSIC ACCESSORIES**

**SONIC FOOT**

Sonic adjustable foot for floor mounting.

In green RAL 6011 45.10.00  
In grey RAL 7035 45.10.10

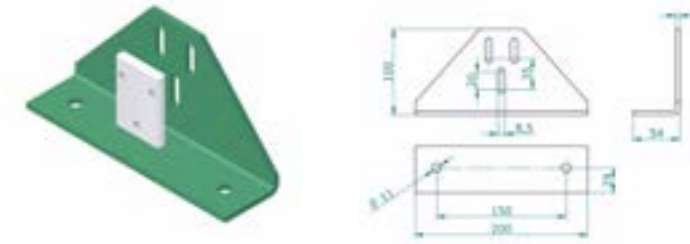

**CONSOLE FUME EXTRACTOR**

Width 2.000 mm

45.30.15.2022

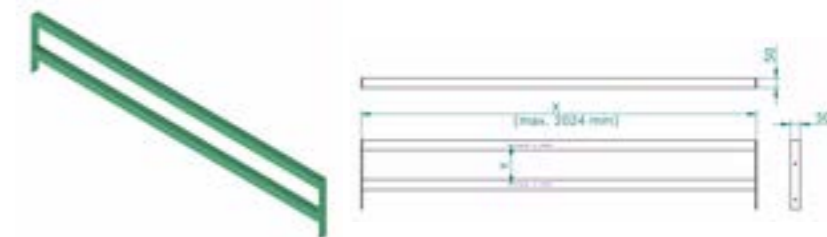

**EXTENSION ADJUSTABLE FOOT**

Extension for fitting an extra foot to a Sonic wall element.

The extension is galvanized.

45.35.20

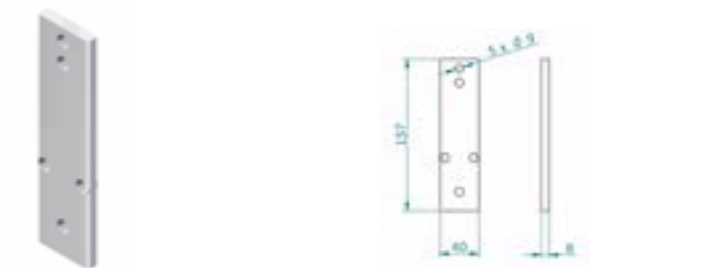

**SUPPORT**

Support for fixing rail or tube support.

This support is galvanized.

80.10.01



**SUPPORT, SPECIAL VERSION**

Support for fixing rail or tube support to the side of a Sonic wall element.

This support is galvanized.

Left version 45.35.02  
Right version 45.35.03

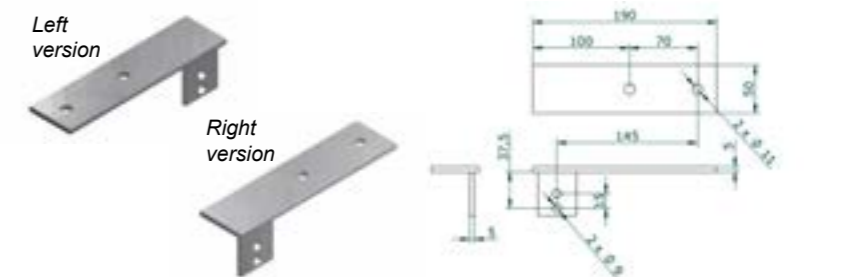

**SUPPORT EXTRA LONG**

Support for fixing rail or tube support, extra long version

This support is galvanized.

45.35.05

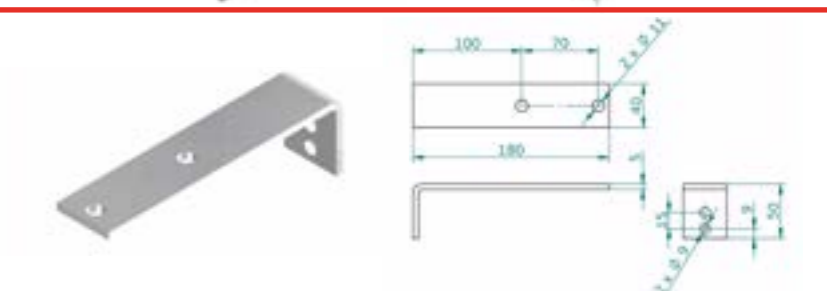



► **CEPRO SONIC CLASSIC GRINDING BOOTHS**

- Height 2,500 mm
- Walls are perforated on the inside only
- Thickness 50 mm
- RAL 6011 powder coated
- Fitted with floor profiles
- Door fitted with an anti-panic closing

► **CEPRO SONIC CLASSIC GRINDING BOOTH**

Width 2,124 mm  
Depth 2,124 mm  
Height 2,552 mm

The elements are perforated on the inside only. The booth is fitted with a sound insulating door, which is provided with an anti-panic closing on the inside and a door catch on the outside.

CEPRO grinding booths are standard finished in powder coating, colour green RAL 6011. The color of the door is RAL 9006.

on request

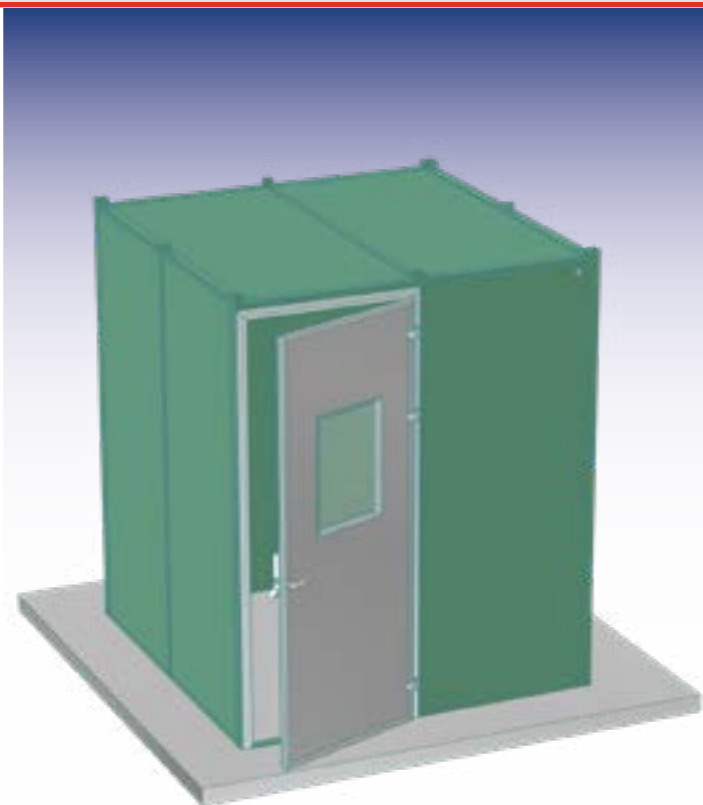

► **CEPRO WORKPLACE SEPARATION**

► **SONIC SOUND INSULATING SCREEN**

Height 2,208 mm  
Width 2,124 mm  
Thickness 50 mm

This screen is made of two Sonic elements which are placed in a movable frame. In this way you will have utmost flexibility in shielding the source of noise in your workplace.

Movable on four heavy duty castors (100mm Ø) with brake, finished in powder coating green RAL 6011.

on request

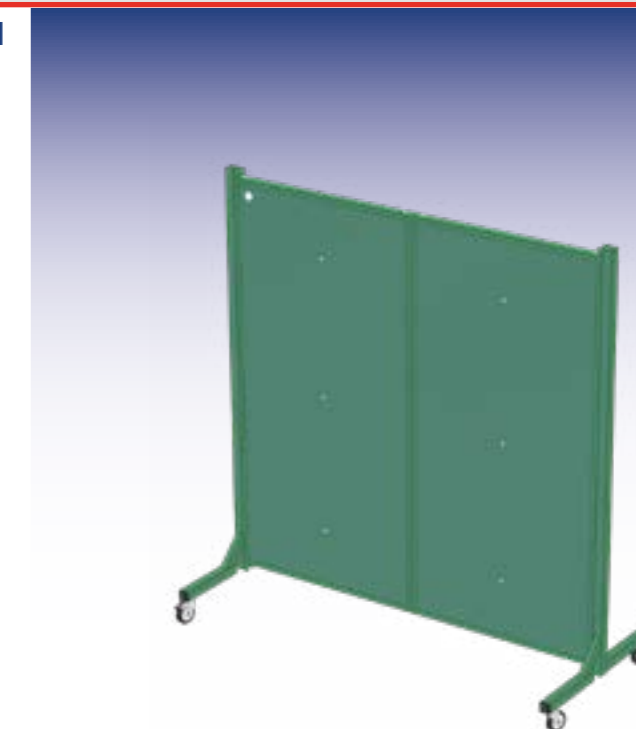

► **CEPRO SONIC CLASSIC GRINDING BOOTH**

Width 3,136 mm  
Depth 2,124 mm  
Height 2,552 mm

The elements are perforated on the inside only. The booth is fitted with a sound insulating door, which is provided with an anti-panic closing on the inside and a door catch on the outside.

CEPRO grinding booths are standard finished in powder coating, colour green RAL 6011. The color of the door is RAL 9006.

on request

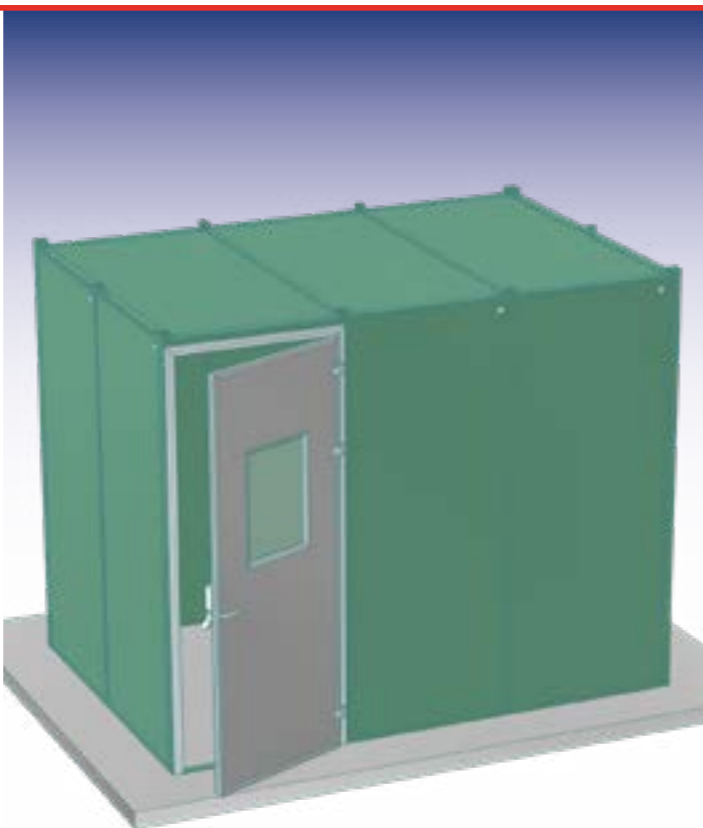

► **SONIC SOUND ABSORBING CURTAIN**

A sound absorbing curtain which offers protection against noise nuisance. Fitted on the top side with metal eyelets.

Only available as a custom curtain. Maximum width 150cm, separate curtains to be connected with a Velcro closure. One side mesh and one side PVC coated fabric. Per square meter.

92.15.01 on request



(fitted in Cepro Robusto screen)

► **UniSonic working booths**

**MAIN FEATURES**



Booth shown is 300 x 285 cm

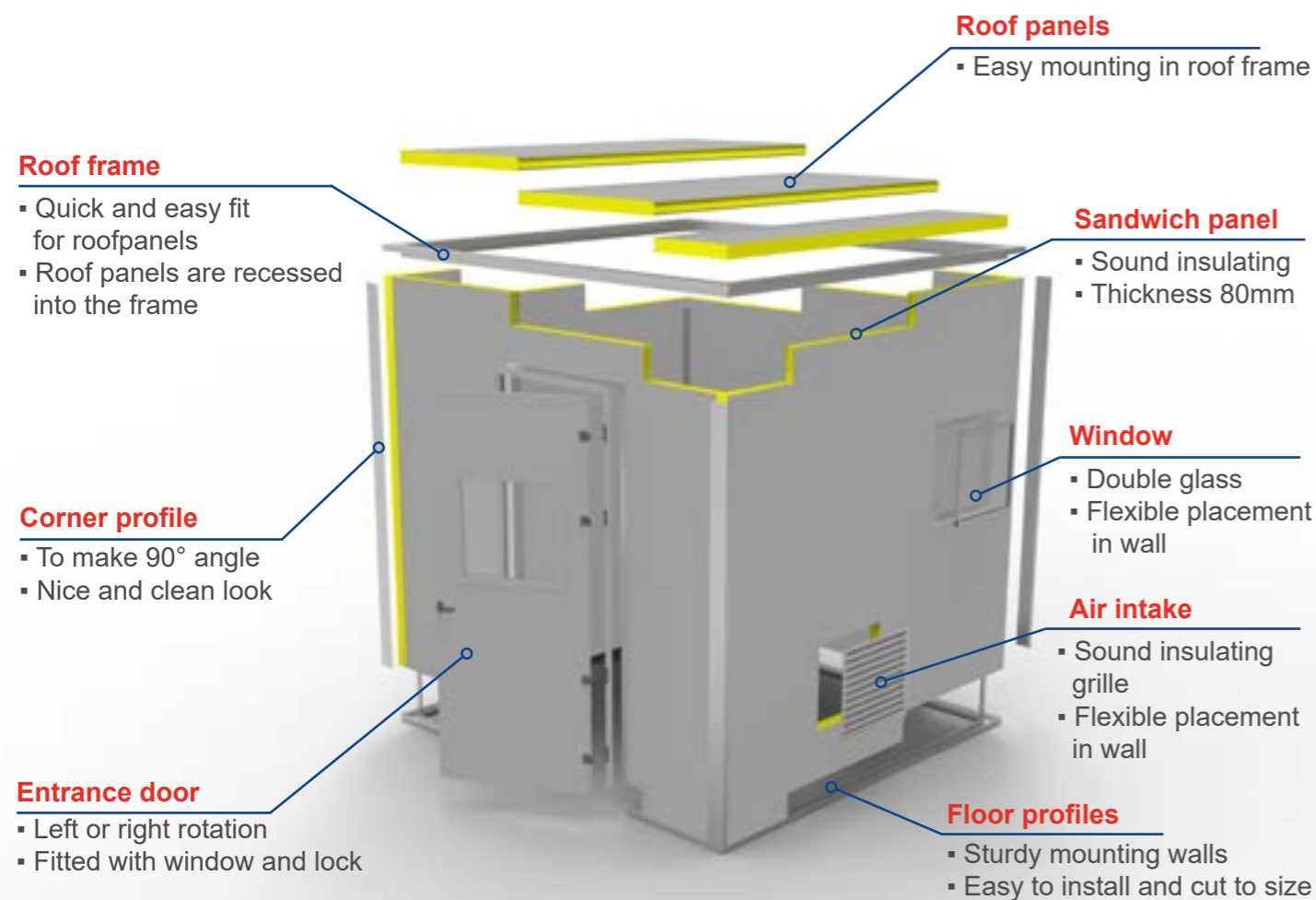

**USP'S**

- Easy to calculate and build, due to **limited** components
- Competitively priced, within the standard configurations
- Available from stock so quick delivery times
- Excellent price / quality ratio
- Multifunctional use in a variety of work places
- Seamless installation with tongue and groove system
- Easy to add windows, doors, air-inlets etc

**APPLICATIONS**

- Spray booth
- Grinding booth
- Storage
- Temporary office space
- Laser (*laser safety windows available on request, delivery of supplementary safety systems available soon*).

**SPECIFICATIONS**

- Material EPS with steel sheeting
- Thickness 80 mm
- Colour RAL 9006
- Weight 10.4 kg/m<sup>2</sup>
- Link panels with tongue / groove
- Standard heights 270 cm or 390 cm

**Price on request**



► **UniSonic laser booths**

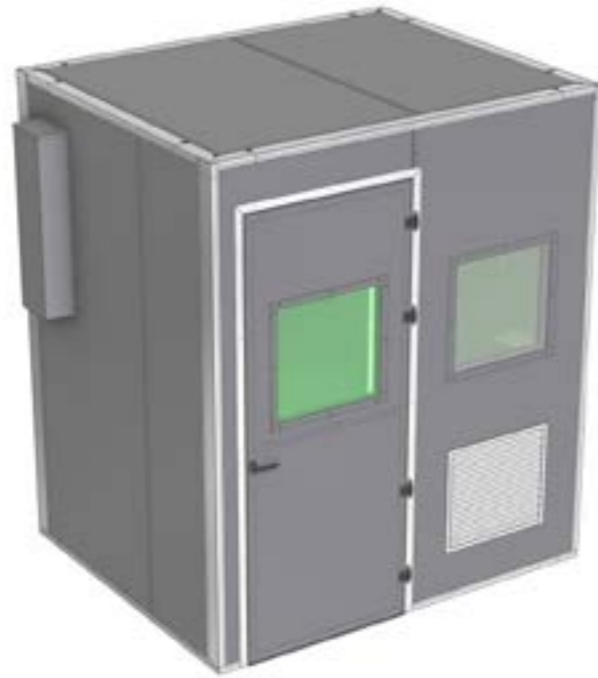

Booth dimension 245 x 170 cm, x 270 cm

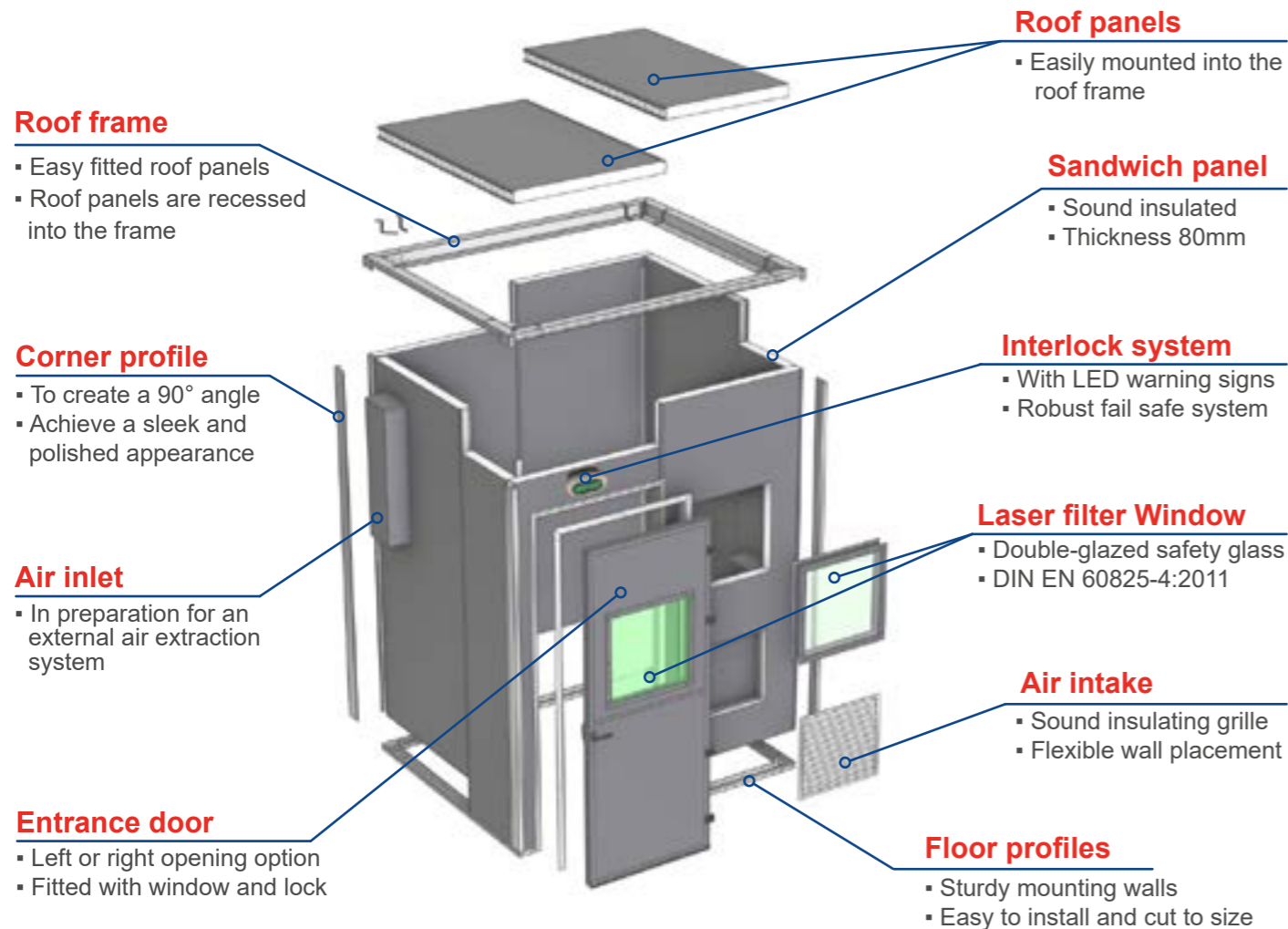

**SPECIFIC LASER FEATURES**

- Entry doors are equipped with a robust fail safe interlock system, with LED warning lights
- Pilz door sensor
- Laser filter window DIN EN 60825-4:2011  
wavelength range 897-960 nm - 124 kW/m<sup>2</sup> - T2  
wavelength range 960-1190 nm - 166 kW/m<sup>2</sup> - T2
- Control box with manual reset button
- Air inlet, labyrinth gaps and grid

**USPS UNISONIC ELEMENTS**

- Easy to design and build with minimal components
- Competitively priced within the standard configurations
- Available from stock to minimize delivery times
- Excellent price-to-quality ratio
- Multifunctional: suitable for use in a variety of workplaces
- Seamless installation via a tongue & groove system
- Easily add windows, doors, air-inlets, etc

**OTHER APPLICATIONS**

- Spray booth
- Grinding booth
- Storage
- Temporary office space

**SPECIFICATIONS**

- Manufactured from EPS with steel sheeting
- Thickness 80 mm
- Colour RAL 9006
- Weight 10.4 kg/m<sup>2</sup>
- Link panels with tongue & groove system
- Standard heights 270 cm or 390 cm

**Price on request**



**CEPRO WELDING TABLES**

- Height 80 cm
- Made from profiles 40 x 40 mm
- Available with grill top and/or bricks
- RAL 6011 powder coated

**WELDING TABLE WITH GRILL TOP AND BRICKS**

Welding table with grill top and bricks  
width 85 cm      45.41.01.6385

Welding table with grill top and bricks  
width 110 cm      45.41.01.6311

- Height 80 cm
- Depth 63 cm
- Bare metal grill top
- Fire proof bricks



**WELDING TABLE WITH GRILL TOP**

Welding table with grill top  
width 60 cm      45.41.02.6360

Welding table with grill top  
width 85 cm      45.41.02.6385

Welding table with grill top  
width 110 cm      45.41.02.6311

- Height 80cm
- Depth 63cm
- Bare metal grill top



**ACCESORIES WELDING TABLE WITH GRILL TOP AND BRICKS**

Fire proof bricks      45.49.01.0001

Support plate for bricks  
45.49.01.0002

Grill top (bare metal) 620 x 590 mm  
for welding table with grill and bricks 63 x 85 cm  
for welding table with grill 63 x 60 cm  
45.49.02.6259

Grill top (bare metal) 620 x 840 mm  
for welding table with grill and bricks 63 x 110 cm  
for welding table with grill 63 x 85 cm  
45.49.02.6284

Grill top (bare metal) 620 x 1190 mm  
for welding table with grill 63 x 110 cm  
45.49.02.6209

Support for fixing objects to welding table  
45.49.50.0001

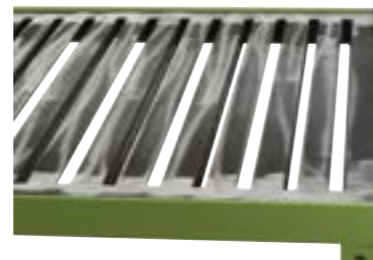

**OUTDOOR WELDING**

When welding in the open air it is important to be protected from all kinds of weather, such as rain, wind, sun, etc. Working conditions are noticeably improved if a welding tent or welding umbrella is used. This level of protection for the welder has proved to contribute to a reduction in sick leave.

**Available products**

The CEPRO outdoor welding program is divided into 2 product groups which are suitable for various applications.

**CEPRO welding tents**

Our welding tents are extremely suitable for work in the open air. Work can be continued for longer periods and due to the improvement of working conditions, sick leave will be greatly reduced.

**CEPRO welding umbrellas**

Our welding umbrellas are specially designed for working outdoors. They provide reliable temporary protection of the work site from sun or rain.



► **CEPRO WELDING UMBRELLAS**

- Flame retardant and water repellent canvas
- Canvas fabric 280 gr/m<sup>2</sup>
- Colour green
- Carrying bag included
- Windbreaker on the top side

► **WELDING UMBRELLA MEDIUM DUTY**

Welding umbrella medium duty  
Ø 220 cm 93.21.20



- Ø 220 cm
- With tilt mechanism
- 10 ribs, length 110 cm
- Mast Ø 28 mm
- Mast in 2 parts, total height 220 cm
- Ends of the ribs are fitted with caps

► **WELDING UMBRELLA HEAVY DUTY**

Welding umbrella heavy duty  
Ø 300 cm 93.71.20



- Ø 300 cm
- Fitted with crank system
- 8 ribs, length 150 cm
- Mast Ø 38 mm
- Mast in 2 parts, total height 220 cm
- Ends of the ribs are fitted with metal caps
- Groundpin included

► **CEPRO WELDING TENTS**

- Approved to the M-2 standard
- PVC fabric 570 gr/m<sup>2</sup>
- Protection skirt 200 mm all-around
- Front and back can be closed with a rope-lock

► **CEPRO WELDING TENT CUBE MODEL**

Welding tent cube model  
200 x 190cm 91.20.11

Cover welding tent cube model  
200 x 190cm 90.20.11

Frame welding tent cube model  
200 x 190cm 90.20.02

- Width 190 cm
- Depth 200 cm
- Height 200 cm
- Ridge height 220 cm
- Frame Ø 25 mm galvanized
- Packing suitable for parcel service



**CEPRO WELDING TENT LD SPECIALS**



Other colours and version are available on request

Please contact our sales department for more information.



**Main features new Heavy Duty working & welding tent**

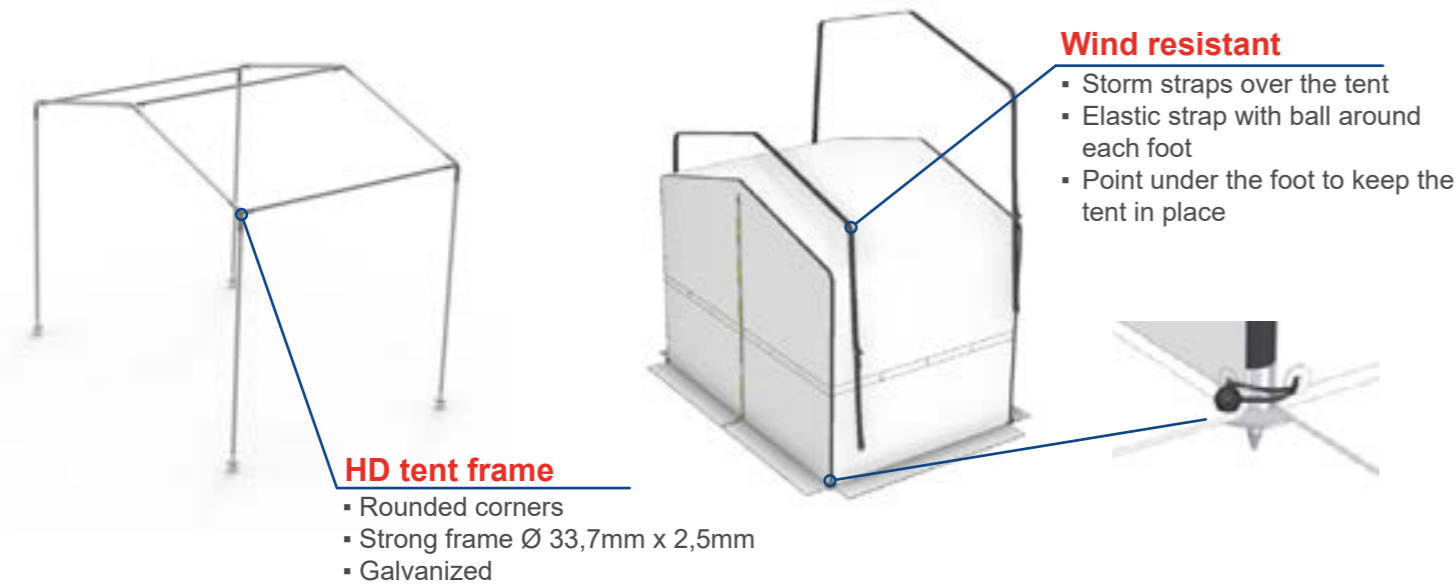
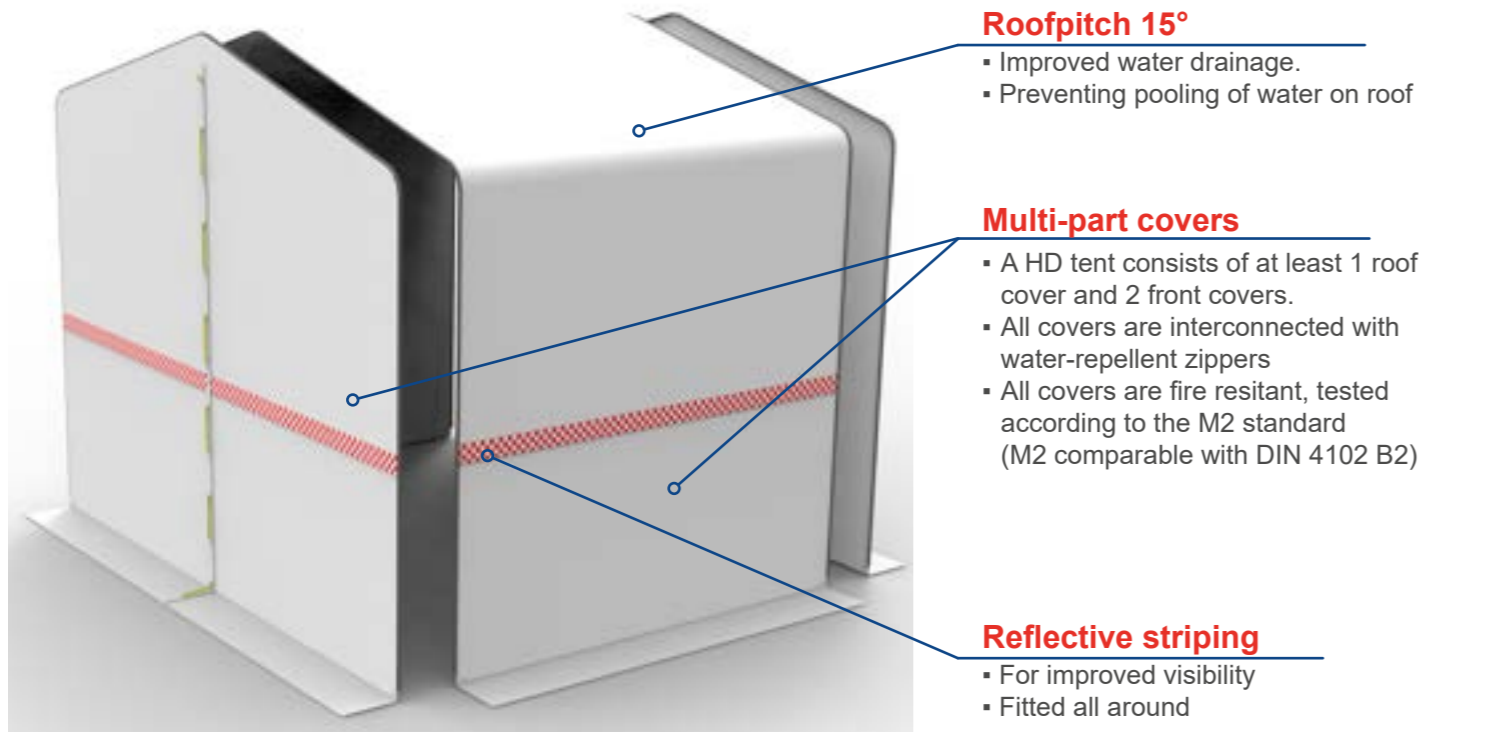

**HD welding /working tent (example)**  
with **2** roofcovers interconnected with water-repellent zippers

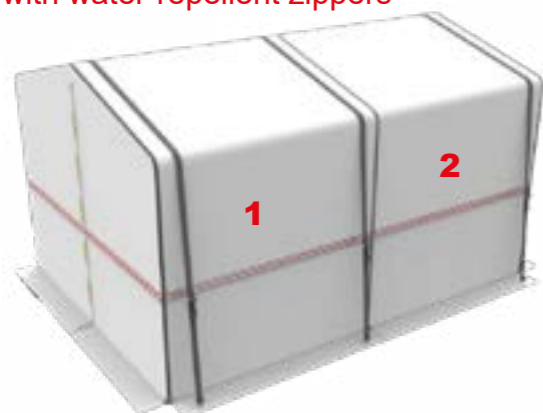

**HD welding /working tent (example)**  
with **4** roofcovers interconnected with water-repellent zippers



**CEPRO HEAVY DUTY WELDING AND WORKING TENT**

- Approved to the M-2 standard
- PVC fabric 570 gr/m<sup>2</sup>
- Protection skirt 200 mm all-around
- Built from standard components
- Front and back can be closed with a rope-lock
- Fitted with reflective striping
- Strong galvanized frame Ø 33.7 mm

**What is included :**

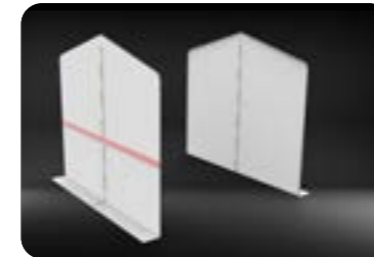

2 Front covers



Multiple roof covers, depending on the depth



Multiple frames, depending on the depth



Multiple storm straps, depending on the depth

**CEPRO HEAVY DUTY TENT - WIDTH 300 CM**

Art. ref.	Width	Depth	Height
90.41.00.3020	300 cm	200 cm	200 cm / 240 cm
90.41.00.3025	300 cm	250 cm	200 cm / 240 cm
90.41.00.3040	300 cm	400 cm	200 cm / 240 cm
90.41.00.3045	300 cm	450 cm	200 cm / 240 cm
90.41.00.3050	300 cm	500 cm	200 cm / 240 cm
90.41.00.3060	300 cm	600 cm	200 cm / 240 cm
90.41.00.3065	300 cm	650 cm	200 cm / 240 cm
90.41.00.3070	300 cm	700 cm	200 cm / 240 cm
90.41.00.3075	300 cm	750 cm	200 cm / 240 cm
90.41.00.3080	300 cm	800 cm	200 cm / 240 cm

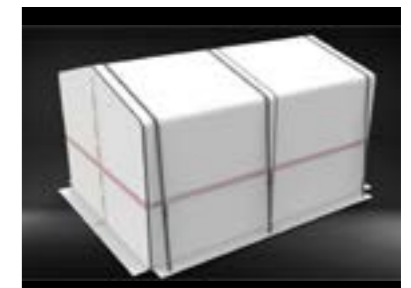

**CEPRO HEAVY DUTY TENT - WIDTH 400 CM**

Art. ref.	Width	Depth	Height
90.41.00.4020	400 cm	200 cm	200 cm / 250 cm
90.41.00.4025	400 cm	250 cm	200 cm / 250 cm
90.41.00.4040	400 cm	400 cm	200 cm / 250 cm
90.41.00.4045	400 cm	450 cm	200 cm / 250 cm
90.41.00.4050	400 cm	500 cm	200 cm / 250 cm
90.41.00.4060	400 cm	600 cm	200 cm / 250 cm
90.41.00.4065	400 cm	650 cm	200 cm / 250 cm
90.41.00.4070	400 cm	700 cm	200 cm / 250 cm
90.41.00.4075	400 cm	750 cm	200 cm / 250 cm
90.41.00.4080	400 cm	800 cm	200 cm / 250 cm

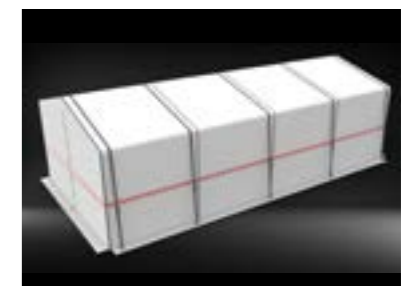

► **CEPRO HEAVY DUTY TENT - COMPONENTS**

**FRONT COVER WITH RUNNER**

Front cover **with** runner and with zipper

- 90.40.30.0001 - Width 300 cm
- 90.40.40.0001 - Width 400 cm

**FRONT COVER WITHOUT RUNNER**

Front cover **without** runner and with zipper

- 90.40.30.0002 - Width 300 cm
- 90.40.40.0002 - Width 400 cm

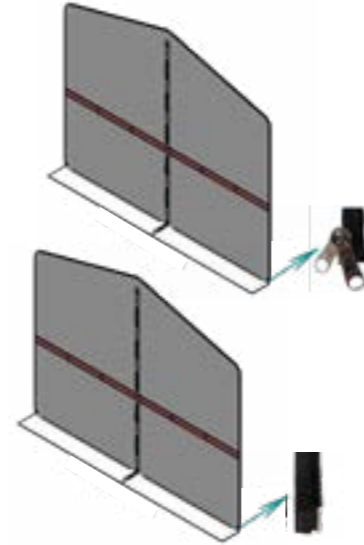

**ROOF COVER 200 CM DEEP**

Roof cover with storm band and elastic straps

- 90.40.3020 - Width 300 cm
- 90.40.4020 - Width 400 cm

**ROOF COVER 250 CM DEEP**

Roof cover with storm band and elastic straps

- 90.40.3025 - Width 300 cm
- 90.40.4025 - Width 400 cm

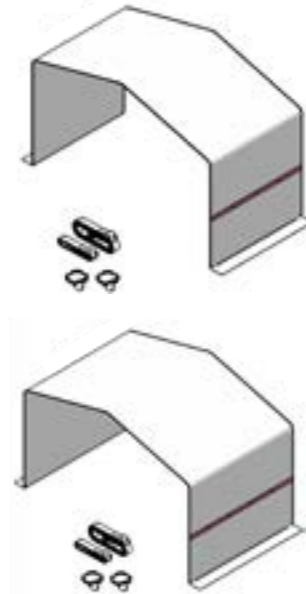

**FRAME COMPONENTS**

- 90.40.01 T-coupling top piece
- 90.40.02 T-coupling side piece
- 90.40.03 X-coupling top piece
- 90.40.04 X-coupling side piece
- 90.40.05 Foot with base pin

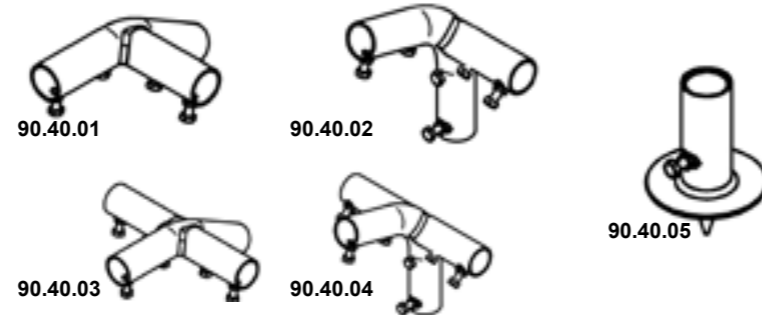

**FRAME TUBES**

- 90.40.20.0140 Tube Ø 33.7 mm, length 140 cm
- 90.40.20.0192 Tube Ø 33.7 mm, length 192 cm
- 90.40.20.0237 Tube Ø 33.7 mm, length 237 cm



**FIXTURES**

- 90.40.10 Storm band and elastic straps (2x)



► **CEPRO HEAVY DUTY TENT - ACCESSORIES**

**FRONT COVER WITH PIPE TRANSFER**

Front cover with an opening for pipe / pipeline. The high-quality cover is cut so that the pipeline is enclosed. This guarantees optimal welding conditions

On request

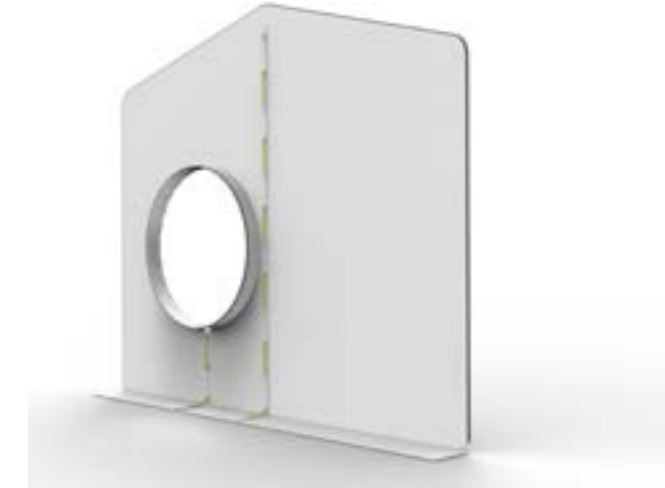

**ROOF COVER WITH PIPE TRANSFER**

Roof cover with an opening for pipe / pipeline. The high-quality cover is cut so that the pipeline is enclosed. This guarantees optimal welding conditions

On request

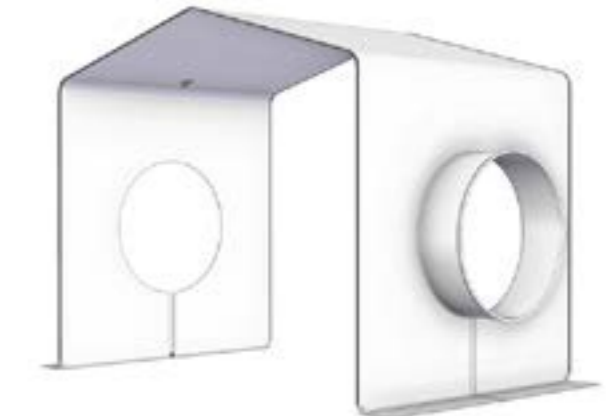

**CRANE HOOK**

Fixture for lifting tent.

On request



**CONSTRUCTION**

CEPRO offers an extensive range of swivel arms, columns and poles and construction parts making it possible to combine a wide variety of protection items and booths. CEPRO swivel arms, columns and poles and construction parts are characterized by their excellent quality and ease of use. You can find the appropriate arm, column or pole and its related supports and mounting parts for each application. We are ready to meet your special requirements. Please consult our sales department.

**Available products**

The CEPRO range includes a large variety of products such as:

- Pipe swivel arm
- Modular swivel arm
- Swivel heavy duty arm
- Swivel joint arm
- Poles and columns
- Rail and tube system parts
- Cable reel

Each of these CEPRO products has been developed for use in specific working conditions for the optimal fit-out of a workplace.

**Made to size**

CEPRO can also offer you tailor made and constructed installations. This goes for dimensions, design and colour scheme. You can count on receiving professional advice from one of our advisors. Please contact our sales department to make an appointment.

**Projects**

CEPRO is a specialist in solutions for specific problems which occur in the welding and grinding work area. Sometimes these problems are isolated problems but mostly they are combinations and are part of an overall safety policy. CEPRO knows more than anybody else how to optimally combine the properties of its different products with those of others into a pleasant workplace which meets all safety and efficiency requirements. During the optimisation of a workplace we are in many cases also confronted with other issues which are important such as concerns about the evacuation of harmful welding gases, the supply of gas and oxygen, air conditioning, communication systems or even the most efficient way of supplying electricity to the workplace.

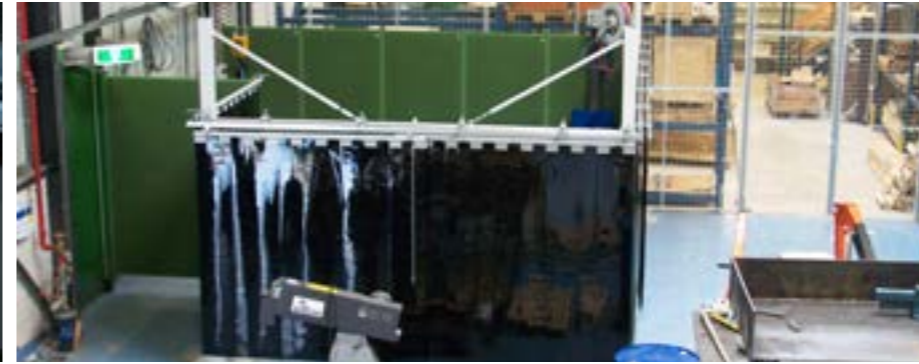



**CEPRO SWIVEL ARMS**

**CEPRO PIPE SWIVEL ARM 200 cm**

Can be swiveled 180°. Maximum length 2 meter, produced from tube of 35 mm Ø. This product is finished with a grey (RAL 7035) powder-coating. Fitted with a mechanical hinge and an assembly plate for fixing the arm against a wall or column.



82.10.15

1. Choose the type of separation; curtains or strip (2 or 3 mm)
2. Choose the required height of the separation
3. Then you will find the suitable pole for this arm and separation. Details on page 63.

82.10.15 Swivel arm length 200cm	Curtain			Strips 300 x 2 mm			Strips 300 x 3 mm		
	Height under beam			Height under beam			Height under beam		
	1,85 mtr	2,10 mtr	2,60 mtr	1,85 mtr	2,10 mtr	2,60 mtr	1,85 mtr	2,10 mtr	2,60 mtr
	83.10.01.0225 50x50x2mm H=2,25 mtr	83.10.01.0250 50x50x2mm H=2,50 mtr	83.10.01.0300 50x50x2mm H=3,00 mtr	83.10.01.0225 50x50x2mm H=2,25 mtr	83.10.02.0250 80x80x3mm H=2,50 mtr	83.10.02.0300 80x80x3mm H=3,00 mtr	83.10.02.0225 80x80x3mm H=2,25 mtr	83.10.02.0250 80x80x3mm H=2,50 mtr	on request

**CEPRO SWIVEL ARM 200 cm**

Can be swiveled 180°. Maximum length 2 meter, produced from rectangular tube of 50 x 50 mm. This product is finished with a grey (RAL 7035) powder-coating. Fitted with a mechanical hinge and an assembly plate for fixing the arm against a wall or column.



82.10.36.0200

1. Choose the type of separation; curtains or strip (2 or 3 mm)
2. Choose the required height of the separation
3. Then you will find the suitable pole for this arm and separation. Details on page 63.

82.10.36 Swivel arm length 200cm	Curtain			Strips 300 x 2 mm			Strips 300 x 3 mm		
	Height under beam			Height under beam			Height under beam		
	2,15 mtr	2,30 mtr	2,80 mtr	2,15 mtr	2,30 mtr	2,80 mtr	2,15 mtr	2,30 mtr	2,80 mtr
	83.10.02.0225 80x80x3mm H=2,25 mtr	83.10.02.0250 80x80x3mm H=2,50 mtr	83.10.02.0300 80x80x3mm H=3,00 mtr	83.10.02.0225 80x80x3mm H=2,25 mtr	83.10.02.0250 80x80x3mm H=2,50 mtr	83.10.02.0300 80x80x3mm H=3,00 mtr	83.20.02.0225 100x100x4mm H=2,25 mtr	83.20.01.0250 100x100x4mm H=2,50 mtr	83.20.01.0300 100x100x4mm H=3,00 mtr

**CEPRO SWIVEL ARMS**

**CEPRO MODULAR SWIVEL ARM**

Can be swiveled 180°. Produced from a rectangular tube 50 x 50 mm. This product is finished with a grey (RAL 7035) powder-coating. The swivel arm is fitted with a brake system and an assembly plate for fixing the arm against a wall or column.



200cm version 82.10.30.0200  
300cm version 82.10.30.0300  
400cm version 82.10.30.0400  
500cm version 82.10.30.0500

1. Choose the type of separation; curtains or strip (2 or 3 mm)
2. Choose the required height of the separation
3. Then you will find the suitable pole for this arm and separation.

	Curtain			Strips 300 x 2 mm			Strips 300 x 3 mm		
	Height under beam			Height under beam			Height under beam		
	2,20 mtr	2,70 mtr	3,20 mtr	2,20 mtr	2,70 mtr	3,20 mtr	2,20 mtr	2,70 mtr	3,20 mtr
<b>82.10.30.0200</b> swivel arm length 200cm	83.10.02.0300 80x80x3mm H=3,00 mtr	83.10.02.0350 80x80x3mm H=3,50 mtr	83.10.02.0400 80x80x3mm H=4,00 mtr	83.10.02.0300 80x80x3mm H=3,00 mtr	83.10.02.0350 80x80x3mm H=3,50 mtr	83.20.01.0400 100x100x4mm H=4,00 mtr	83.20.01.0300 100x100x4mm H=3,00 mtr	83.20.01.0350 100x100x4mm H=3,50 mtr	83.20.01.0400 100x100x4mm H=4,00 mtr
<b>82.10.30.0300</b> swivel arm length 300cm	83.10.02.0300 80x80x3mm H=3,00 mtr	83.10.02.0350 80x80x3mm H=3,50 mtr	83.10.02.0400 80x80x3mm H=4,00 mtr	83.20.01.0300 100x100x4mm H=3,00 mtr	83.20.01.0350 100x100x4mm H=3,50 mtr	83.20.02.0400 120x120x5mm H=4,00 mtr	83.20.02.0300 120x120x5mm H=3,00 mtr	83.20.02.0350 120x120x5mm H=3,50 mtr	83.20.02.0400 120x120x5mm H=4,00 mtr
<b>82.10.30.0400</b> swivel arm length 400cm	83.10.02.0300 80x80x3mm H=3,00 mtr	83.10.02.0350 80x80x3mm H=3,50 mtr	83.10.02.0400 80x80x3mm H=4,00 mtr	83.20.02.0300 120x120x5mm H=3,00 mtr	83.20.02.0350 120x120x5mm H=3,50 mtr	83.20.02.0400 120x120x5mm H=4,00 mtr	83.20.02.0300 120x120x5mm H=3,00 mtr	on request	op aanvraag
<b>82.10.30.0500</b> swivel arm length 500cm	83.20.01.0300 100x100x4mm H=3,00 mtr	83.20.01.0350 100x100x4mm H=3,50 mtr	83.20.01.0400 100x100x4mm H=4,00 mtr	83.20.02.0300 120x120x5mm H=3,00 mtr	83.20.02.0350 120x120x5mm H=3,50 mtr	on request	on request	on request	on request

**CEPRO SWIVEL ARM HEAVY DUTY 600CM**

Swivel arm, maximum length 6 meter, girder made from rectangular tube 50 x 50 mm. This product is finished with a grey (RAL 7035) powder-coating. This arm is fitted with a hinge in a block bearing with and a mechanical lock. An assembly plate for fixing the arm to a column or pole is included.



82.10.45.0600

1. Choose the type of separation; curtains or strip (2 or 3 mm)
2. Choose the required height of the separation
3. Then you will find the suitable pole for this arm and separation. Details on page 63.

82.10.45 Swivel arm length 600cm	Curtain			Strips 300 x 2 mm			Strips 300 x 3 mm		
	Height under beam			Height under beam			Height under beam		
	2,05 mtr	2,55 mtr	3,05 mtr	2,05 mtr	2,55 mtr	3,05 mtr	2,05 mtr	2,55 mtr	3,05 mtr
	83.20.02.0300 120x120x5mm H=3,00 mtr	83.20.02.0350 120x120x5mm H=3,50 mtr	83.20.02.0400 120x120x5mm H=4,00 mtr	83.20.03.0300 160x160x6mm H=3,00 mtr	83.20.03.0350 160x160x6mm H=3,50 mtr	83.20.03.0400 160x160x6mm H=4,00 mtr	on request	on request	on request

**CEPRO SWIVEL ARMS**

**CEPRO SWIVEL ARMS**

**CEPRO SWIVEL ARM HEAVY DUTY HINGED 600CM**

Swivel arm, 6 meter (4 + 2 meters), made with a double girder 50 x 50 mm. This first part swivels in a block bearing and has a mechanical lock. The second part has an adjustable brake system. This part has a maximum radius of 2 x 112°. An assembly plate for fixing the arm to a column or pole is included.

82.10.50.0600



1. Choose the type of separation; curtains or strip (2 or 3 mm)
2. Choose the required height of the separation
3. Then you will find the suitable pole for this arm and separation. Details on page 63.

82.10.50 Swivel arm length 600cm	Curtain			Strips 300 x 2 mm			Strips 300 x 3 mm		
	Heigth under beam			Heigth under beam			Heigth under beam		
	2,05 mtr	2,55 mtr	3,05 mtr	2,05 mtr	2,55 mtr	3,05 mtr	2,05 mtr	2,55 mtr	3,05 mtr
	83.20.02.0300 120x120x5mm H=3,00 mtr	83.20.03.0350 160x160x6mm H=3,50 mtr	83.20.03.0400 160x160x6mm H=4,00 mtr	83.20.03.0300 160x160x6mm H=3,00 mtr	on request	on request	on request	on request	on request

**CEPRO SWIVEL ARM HEAVY DUTY 400CM**

Swivel arm, maximum length 4 meter, double girder made from rectangular tube 50 x 50 mm. This arm is fitted with a hinge in a block bearing with and a mechanical lock. An assembly plate for fixing the arm to a column or pole is included.

82.10.51.0400

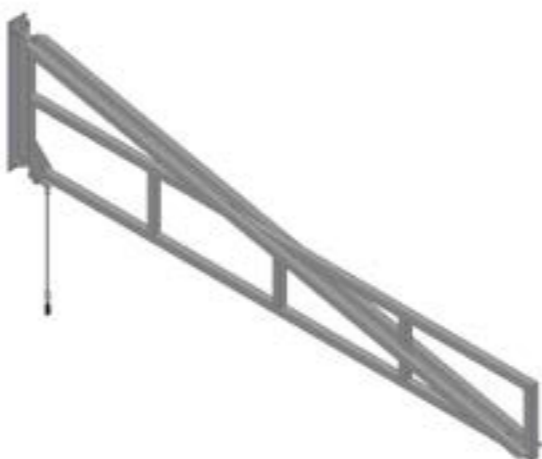

1. Choose the type of separation; curtains or strip (2 or 3 mm)
2. Choose the required height of the separation
3. Then you will find the suitable pole for this arm and separation. Details on page 63.

82.10.51 Swivel arm length 400cm	Curtain			Strips 300 x 2 mm			Strips 300 x 3 mm		
	Heigth under beam			Heigth under beam			Heigth under beam		
	2,05 mtr	2,55 mtr	3,05 mtr	2,05 mtr	2,55 mtr	3,05 mtr	2,05 mtr	2,55 mtr	3,05 mtr
	83.20.02.0300 120x120x5mm H=3,00 mtr	83.20.02.0350 120x120x5mm H=3,50 mtr	83.20.02.0400 120x120x5mm H=4,00 mtr	83.20.03.0300 160x160x6mm H=3,00 mtr	83.20.03.0350 160x160x6mm H=3,50 mtr	83.20.03.0400 160x160x6mm H=4,00 mtr	83.20.03.0300 160x160x6mm H=3,00 mtr	83.20.03.0350 160x160x6mm H=3,50 mtr	on request

**CEPRO TELESCOPIC SWIVEL ARM**

This swivel arm is fitted with a telescope. The hinge of the arm is fitted with an adjustable brake. The swivel arm can be used with both strips and curtains, but is not suitable for heavy loads like a wire-box.

- 200 cm version 82.10.25.2000
- 250 cm version 82.10.25.2500
- 300 cm version 82.10.25.3000
- 350 cm version 82.10.25.3500
- 400 cm version 82.10.25.4000



1. Choose the type of separation; curtains or strip (2 or 3 mm)
2. Choose the required height of the separation
3. Then you will find the suitable pole for this arm and separation.

	Curtain			Strips 300 x 2 mm			Strips 300 x 3 mm		
	Heigth under beam			Heigth under beam			Heigth under beam		
	2,80 mtr	3,30 mtr	3,80 mtr	2,80 mtr	3,30 mtr	3,80 mtr	2,80 mtr	3,30 mtr	3,80 mtr
82.10.25.0200 swivel arm length 200cm	83.10.02.0300 80x80x3mm H=3,00 mtr	83.10.02.0350 80x80x3mm H=3,50 mtr	83.10.02.0400 80x80x3mm H=4,00 mtr	83.10.02.0300 80x80x3mm H=3,00 mtr	83.10.02.0350 80x80x3mm H=3,50 mtr	83.20.01.0400 100x100x4mm H=4,00 mtr	83.20.01.0300 100x100x4mm H=3,00 mtr	83.20.01.0350 100x100x4mm H=3,50 mtr	83.20.02.0400 120x120x5mm H=4,00 mtr
82.10.25.0300 swivel arm length 300cm	83.10.02.0300 80x80x3mm H=3,00 mtr	83.10.02.0350 80x80x3mm H=3,50 mtr	83.10.02.0400 80x80x3mm H=4,00 mtr	83.20.01.0300 100x100x4mm H=3,00 mtr	83.20.02.0350 120x120x5mm H=3,50 mtr	83.20.02.0400 120x120x5mm H=4,00 mtr	83.20.02.0300 120x120x5mm H=3,00 mtr	83.20.02.0350 120x120x5mm H=3,50 mtr	83.20.02.0400 120x120x5mm H=4,00 mtr
82.10.25.0400 swivel arm length 400cm	83.20.01.0300 100x100x4mm H=3,00 mtr	83.20.01.0350 100x100x4mm H=3,50 mtr	83.10.01.0400 100x100x4mm H=4,00 mtr	83.20.02.0300 100x100x4mm H=3,00 mtr	83.20.02.0350 120x120x5mm H=3,50 mtr	83.20.02.0400 120x120x5mm H=4,00 mtr	on request	on request	on request

**CEPRO SWIVEL JOINT ARM - BASIC PART**

Foldable swivel arm, with 2 joints. The first part has a adjustable brake system. This swivel arm can be extended with parts of 60 cm, with a maximum length of 211 cm. This product is finished with a grey (RAL 7035) powdercoating.

- 82.10.30.9005 Mounting plate piece
- 82.10.17.02 Basic part piece
- 82.10.17.03 Extention part piece
- 82.10.17.04 Z-support for swivel arm piece
- 82.10.15 Tube swivel arm piece

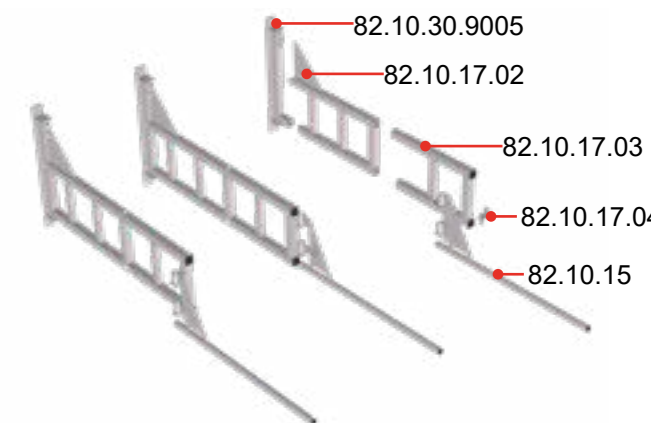

1. Choose the type of separation; curtains or strip (2 or 3 mm)
2. Choose the required height of the separation
3. Then you will find the suitable pole for this arm and separation. Details on page 63.

	Curtain			Strips 300 x 2 mm			Strips 300 x 3 mm		
	Heigth under beam			Heigth under beam			Heigth under beam		
	2,20 mtr	2,70 mtr	3,20 mtr	2,20 mtr	2,70 mtr	3,20 mtr	2,20 mtr	2,70 mtr	3,20 mtr
82.10.17.0921 swivel arm length 300cm	83.10.02.0300 80x80x3mm H=3,00 mtr	83.10.02.0350 80x80x3mm H=3,50 mtr	83.10.02.0400 80x80x3mm H=4,00 mtr	83.20.01.0300 100x100x4mm H=3,00 mtr	83.20.01.0350 100x100x4mm H=3,50 mtr	83.20.02.0400 120x120x5mm H=4,00 mtr	83.20.02.0300 120x120x5mm H=3,00 mtr	83.20.02.0350 120x120x5mm H=3,50 mtr	83.20.02.0400 120x120x5mm H=4,00 mtr
82.10.17.1521 swivel arm length 350cm	83.10.02.0300 80x80x3mm H=3,00 mtr	83.10.02.0350 80x80x3mm H=3,50 mtr	83.20.01.0400 100x100x4mm H=4,00 mtr	83.20.02.0300 120x120x5mm H=3,00 mtr	83.20.02.0350 120x120x5mm H=3,50 mtr	83.20.02.0400 120x120x5mm H=4,00 mtr	83.20.02.0300 120x120x5mm H=3,00 mtr	83.20.02.0350 120x120x5mm H=3,50 mtr	on request
82.10.17.2121 swivel arm length 400cm	83.20.01.0300 100x100x4mm H=3,00 mtr	83.20.01.0350 100x100x4mm H=3,50 mtr	83.20.01.0400 100x100x4mm H=4,00 mtr	83.20.02.0300 120x120x5mm H=3,00 mtr	83.20.02.0350 120x120x5mm H=3,50 mtr	83.20.02.0400 120x120x5mm H=4,00 mtr	83.20.02.0300 120x120x5mm H=3,00 mtr	on request	on request

► **CEPRO POLES & COLUMNS**

► **SET FOR FIXING TUBE UNDER SWIVEL ARM**

Standard set for fixing a tube 33.7 mm Ø under a swivel arm  
82.10.30 + 82.10.17

80.15.02

Standard set for fixing a tube 33.7 mm Ø under a swivel arm  
82.10.36 + 82.10.45 + 82.10.50 + 82.10.51

80.15.01

Supports are galvanized.

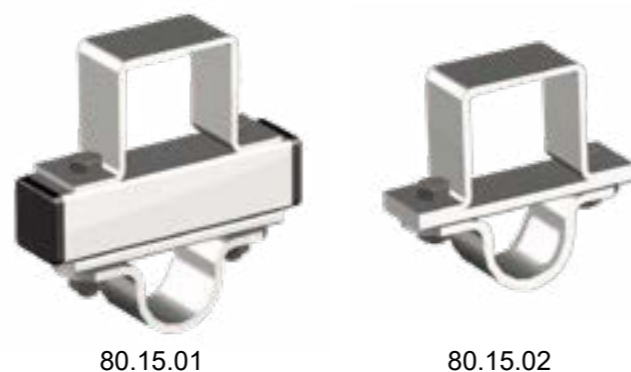

► **SET FOR FIXING RAIL UNDER SWIVEL ARM**

Standard set for fitting rail 30 x 35 mm under a swivel arm  
82.10.30 + 82.10.17

80.15.03

Standard set for fixing a rail 30 x 35 mm under a swivel arm  
82.10.45 + 82.10.50 + 82.10.51

80.15.10

Supports are galvanized.

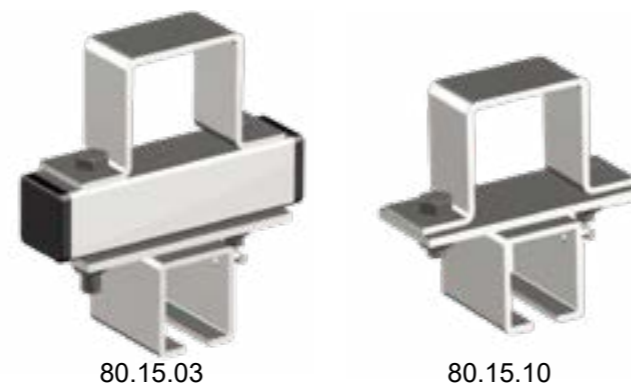

► **TAG WITH RUNNER**

Tag with swivel for fitting hoses into rail system, including runner and snaphook. Tag is made from nylon.

80.10.05



► **FIXING SET FOR WIRE-BOX**

Set for fitting wire-box under a swivel arm, incl. runners, heavy-duty hook and chain with grip Maximum load 25 kg.

82.01.02



► **CEPRO POLES & COLUMNS**

► **CEPRO POLE - 50X50X2MM**

Pole, with a steel pole 50 x 50 x 2 mm and a footplate 110 x 110 x 8 mm.

This product is finished with a grey (RAL 7035) powder coating.

Height 225cm	83.10.01.0225
Height 250cm	83.10.01.0250
Height 300cm	83.10.01.0300



► **CEPRO POLE 300CM**

Poles. Finished with a grey (RAL 7035) powder coating.

**Profile 80x80x3 mm, footplate 300x300x10 mm**

Height 225cm	83.10.02.0225
Height 250cm	83.10.02.0250
Height 300cm	83.10.02.0300
Height 350cm	83.10.02.0350
Height 400cm	83.10.02.0400 <b>on demand</b>

**Profile 100x100x4 mm, footplate 500x500x15 mm**

Height 300cm	83.20.01.0300
Height 350cm	83.20.01.0350
Height 400cm	83.20.01.0400

**Profile 120x120x5 mm, footplate 500x500x15 mm**

Height 300cm	83.20.02.0300
Height 350cm	83.20.02.0350
Height 400cm	83.20.02.0400

**Profile 160x160x6 mm, footplate 500x500x15 mm**

Height 300cm	83.20.03.0300
Height 350cm	83.20.03.0350
Height 400cm	83.20.03.0400

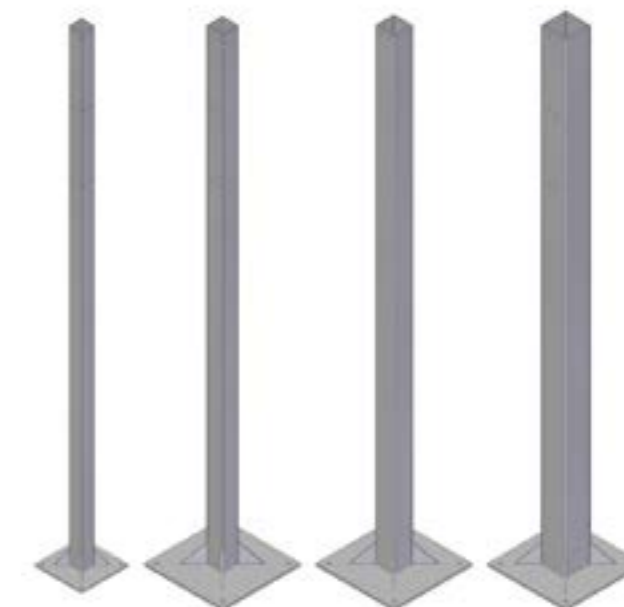

► **CEPRO RAIL SYSTEM**

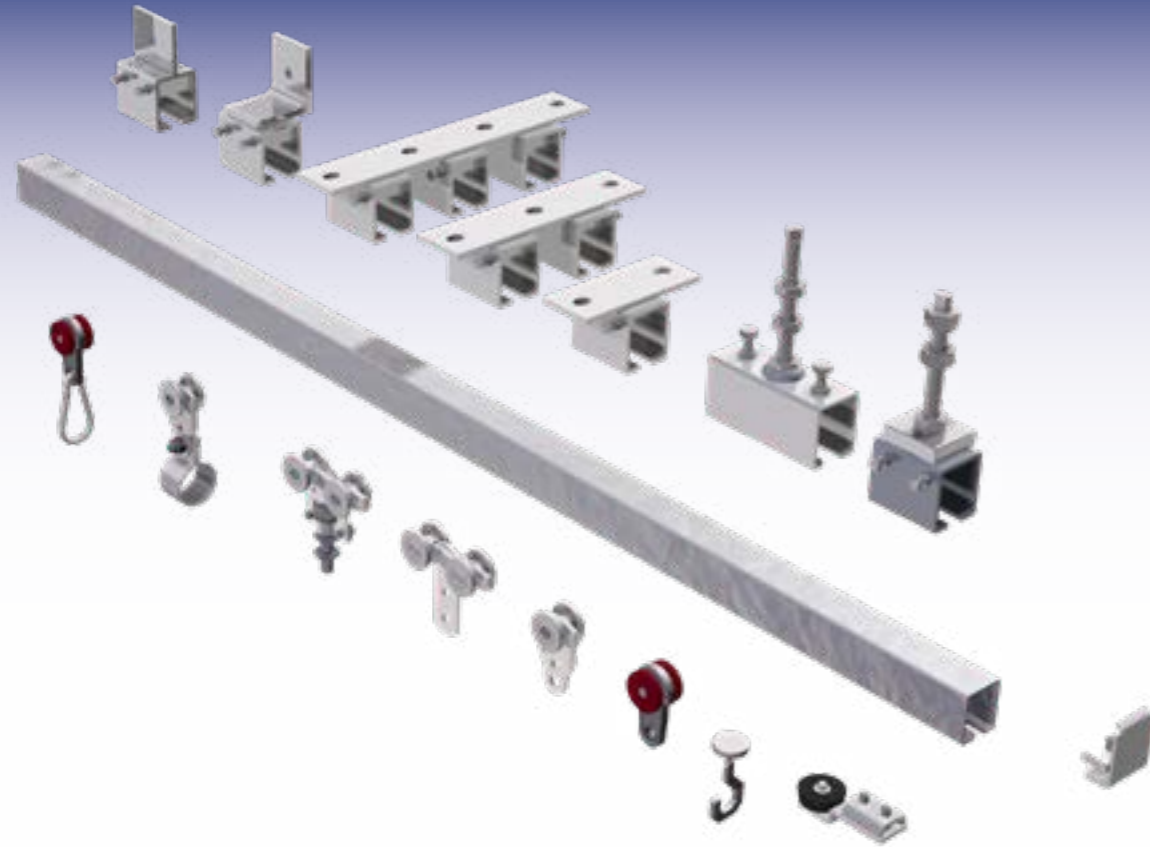

**RAIL SUPPORT**  
Rail support with long bolt M10 for rail 30 x 35 mm

86.10.02

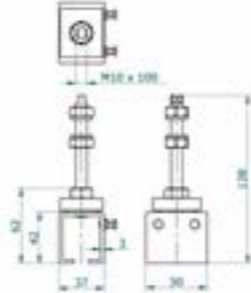

**RAIL CONNECTOR**  
Rail connector with long bolt M10. For rail 30 x 35 mm

86.10.03

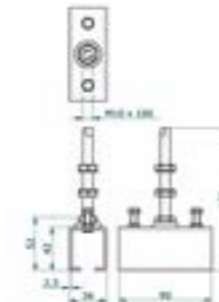

**CEILING CONNECTOR**  
Ceiling rail connector for single rail 30 x 35 mm

86.10.20

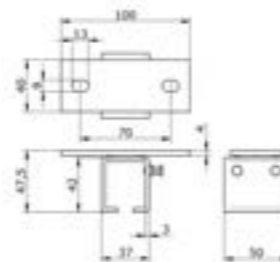

► **CEPRO RAIL SYSTEM**

**CEILING CONNECTOR**

Ceiling rail connector for double rail 30 x 35 mm

86.10.21

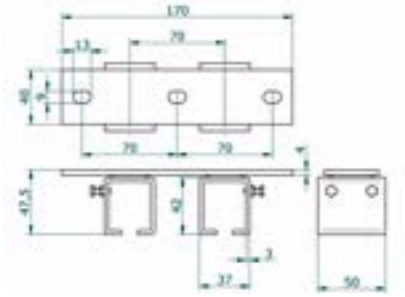

**CEILING CONNECTOR**

Ceiling rail connector for triple rail 30 x 35 mm

86.10.22

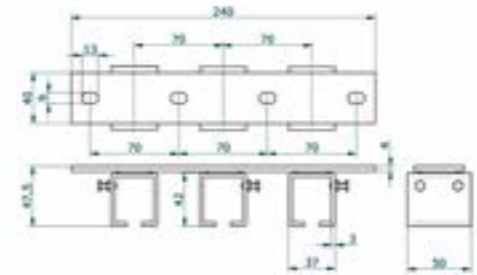

**WALL CONNECTOR**

Wall rail connector for rail 30 x 35 mm

86.10.15

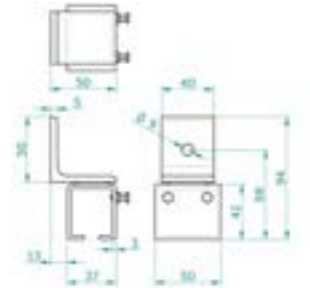

**RAIL 30X35 MM**

Rail 30 x 35 mm per running meter, maximum length 6 meter.

86.10.00

*For logistical reasons we advise the shipment of rail in bundles or in maximum length of 3 meters.*

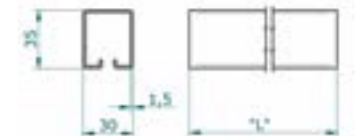

**RAILBEND**

Rail 90° elbow, radius 500 mm, for rail 30 x 35 mm

86.10.01



► **CEPRO RAIL SYSTEM**

**RUNNER PLASTIC**

Two wheel runner plastic, for rail 30 x 35 mm. Suitable for curtains.  
Load capacity 5 kg.

86.10.10

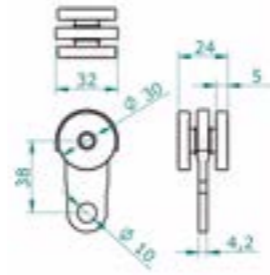

**RUNNER METAL**

Two wheel runner metal, for rail 30 x 35 mm.  
Load capacity 10kg.

86.10.11

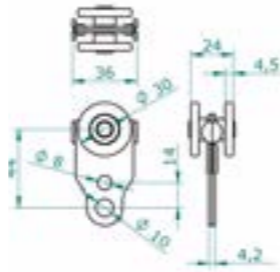

**RUNNER METAL**

Four wheel runner metal, for rail 30 x 35 mm.  
Load capacity 25 kg.

86.10.13

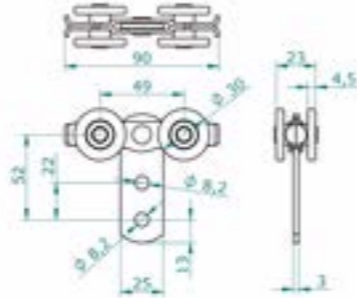

**RUNNER METAL**

Four wheel runner metal, for rail 30 x 35 mm. With threaded end M10 bolt. For rail 30 x 35 mm.  
Load capacity 40 kg.

86.10.17

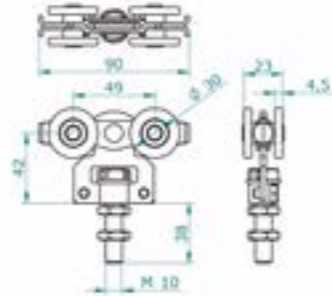

**SNAP HOOK**

Snap hook metal, to be used in combination with a runner to make a curtain separation slideable.

10.48.30

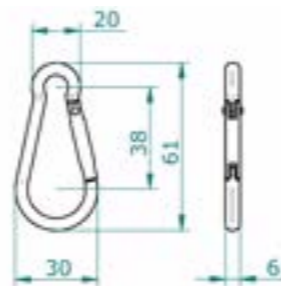

**SLIDE HOOK**

Slide hook plastic, for fixing a curtain into a rail 30 x 35 mm. Only when not used frequently.

10.48.60

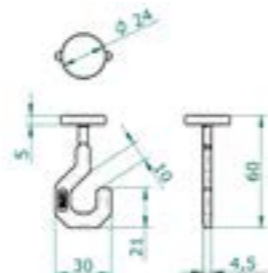

► **CEPRO RAIL SYSTEM**

**ENDPIECE**

End piece for rail 30 x 35 mm

86.10.07

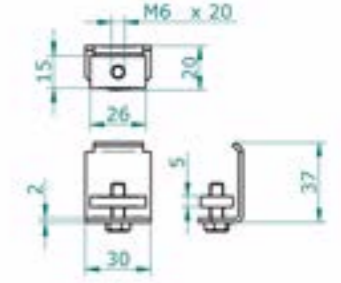

**RAIL STOP**

Rail stop with buffer for rail 30 x 35 mm

86.10.08

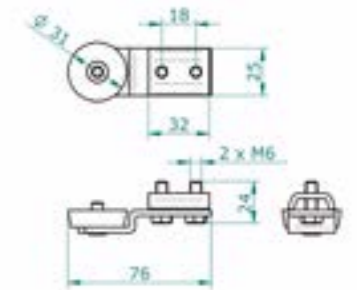

**WALL SUPPORT**

Wall support for rail support parts 86.10.02 or 86.10.03

86.10.04

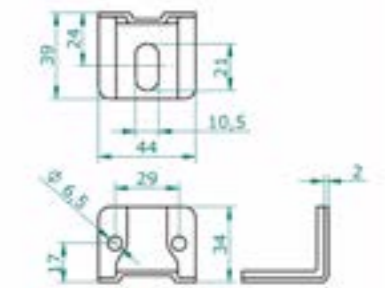

**CEILING SUPPORT**

Ceiling support for rail support parts 86.10.02 or 86.10.03, directly on to a horizontal surface.

86.10.05

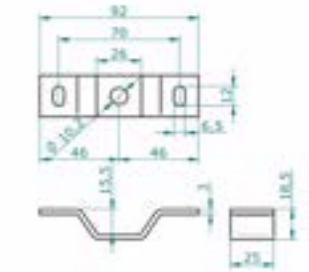

**WALL SUPPORT**

Side wall support for connecting a double rail or pipe to a wall or pole.

80.10.01

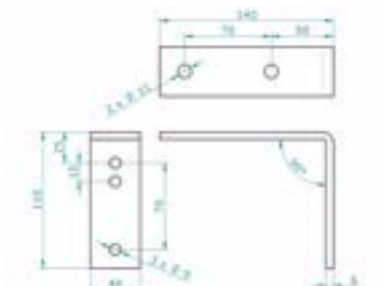

**WALL SUPPORT**

Heavy duty side wall support for connecting a double rail or pipe to a wall or pole.

80.10.02

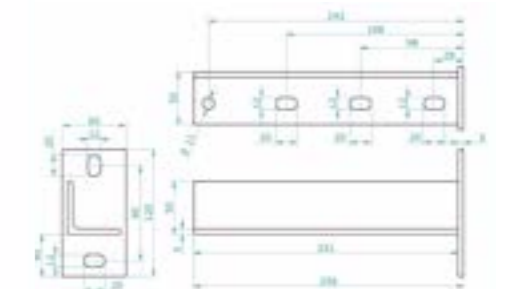

► **CEPRO TUBE SYSTEM**



**CEILING SUPPORT**

Ceiling support, for connecting pipe max 34 mm Ø to the wall or ceiling

86.40.10

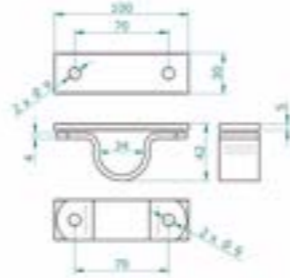

**FLANGE**

Flange, for connecting pipe (33.7 mm Ø, 2.9 mm wall thickness) to a wall or column

86.40.41

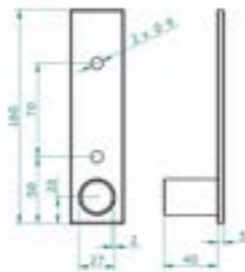

**PIPE SUPPORT**

Pipe support with bolt (M8 x 35 mm) for pipe max 33.7 mm Ø.

86.40.50

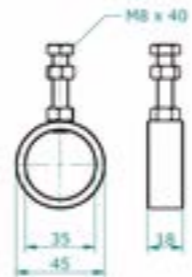

► **CEPRO TUBE SYSTEM**

**TUBE**

Pipe 33.7 mm Ø, 2.9 mm wall thickness per running meter, maximum length 6 meter

86.40.00

*For logistical reasons we advise the shipment of tube in bundles or in maximum length of 3 meters.*

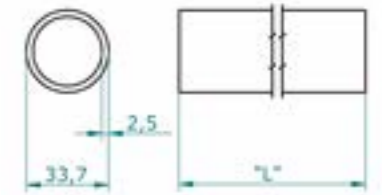

**TUBE CONNECTOR**

Pipe connector for pipe 33.7 mm Ø. Only suitable for use next to a support

86.40.30

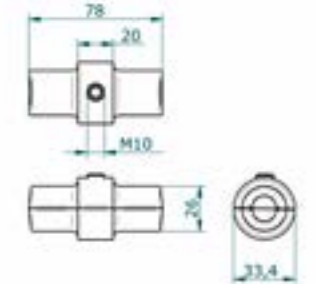

**SUSPENSION RING**

Suspension ring, steel, for pipe max 33.7 mm Ø (packed per set of 7 pieces)

10.48.50.0007



**SUSPENSION RING**

Suspension ring, plastic, for pipe max 33.7 mm Ø.

10.48.40



**SUSPENSION HOOK**

Suspension ring, metal, extra large for heavy duty purposes. For pipe max :

Ø 34 mm 10.48.55

Ø 50 mm 10.48.58

Ø 70 mm 10.48.56

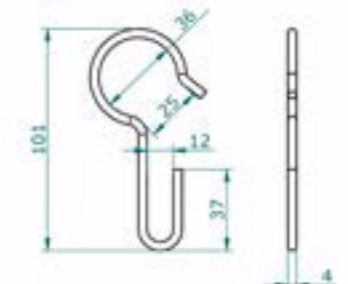

**SUSPENSION RING**

Stainless steel suspension ring. Ø 58 mm.

10.48.52



▶ **CEPRO TUBE SYSTEM**

**PIPE CLAMP**

Pipe clamp, for pipe 33.7 mm Ø.  
To be used in combination with a  
runner to make a strip separation  
slideable.

86.40.20



**END CAP**

End cap, for pipe 33.7 mm Ø,  
2.9 mm wall thickness.

86.40.25



**WALL SUPPORT**

Wall support for rail support  
parts 86.10.02 or 86.10.03

86.10.04



**CEILING SUPPORT**

Ceiling support for rail support  
parts 86.10.02 or 86.10.03,  
directly on to a horizontal  
surface.

86.10.05



**WALL SUPPORT**

Side wall support for  
connecting a double rail or  
pipe to a wall or pole

80.10.01



**WALL SUPPORT**

Heavy duty side wall support  
for connecting a double rail or  
pipe to a wall or pole

80.10.02



▶ **CEPRO CABLE REEL**

- Quick screening off of the workplace
- Easy to operate
- Cable length 8 meter

- Thickness cable 3mm
- Sturdy metal housing

▶ **CEPRO CABLE REEL**

Cable reel, cable length max. 8 meter,  
**without** curtain

82.20.10

- Maximum height curtain 200cm
- Including wall support
- Comes with special tensioning support



▶ **CEPRO WELDING CURTAIN 140 CM WIDE FOR CABLE REEL**

Cepro Orange-CE	H. 160 cm x 140cm	16.15.16
Cepro Orange-CE	H. 180 cm x 140cm	16.15.18
Cepro Orange-CE	H. 200 cm x 140cm	16.15.20
Cepro Green-9	H. 160 cm x 140cm	16.19.16
Cepro Green-9	H. 180 cm x 140cm	16.19.18
Cepro Green-9	H. 200 cm x 140cm	16.19.20
Cepro Green-6	H. 160 cm x 140cm	16.16.16
Cepro Green-6	H. 180 cm x 140cm	16.16.18
Cepro Green-6	H. 200 cm x 140cm	16.16.20
Cepro Bronze-CE	H. 160 cm x 140cm	16.17.16
Cepro Bronze-CE	H. 180 cm x 140cm	16.17.18
Cepro Bronze-CE	H. 200 cm x 140cm	16.17.20

**EN ISO 25980  
APPROVED**



▶ **SUSPENSION RING**

Stainless steel suspension ring for curtain.  
Ø 58 mm.

10.48.52



## Protecting people

**We protect people and the surrounding area from danger by setting up safe welding and grinding sites.**

Solid operational management also means working to protect your employees and the surrounding area from danger. At CEPRO, we believe sharing knowledge about legal safety requirements forms the cornerstone of a productive business relationships and long-term partnership.

### **Reliable quality and service in safety**

This allows us to combine all the knowledge and expertise found in today's sector in our products, services and processes. We treat every request with due care and attention and work to tailor our solutions to the individual requirements of the client or end user. And throughout, we leave nothing to chance. Working together with our client, and together with our partners. We believe that continuously investing in knowledge, training and relationships is the best guarantee for consistent and dependable quality and solid service in safety that complies with international regulations. It's what has made CEPRO the global market leader in its sector.

### **Happy in your job**

When it comes to safety and job satisfaction, only the best is good enough for our own people too. After all, whether or not you are happy in your job depends to a large extent on how secure and satisfied you feel as an employee. When our employees feel happy, this contributes to their personal health and productivity. And this in turn has a positive impact on customer satisfaction.

### **CEPRO International B.V.**

Postal address:  
Provinciënbaan 16  
5121 DL Rijen, The Netherlands

Visiting address:  
Provinciënbaan 16  
5121 DL Rijen, The Netherlands

Warehouse address:  
Provinciënbaan 16  
5121 DL Rijen, The Netherlands

### **Telephone:**

Sales Export  
+31 (0)161 23 01 16

Sales Benelux  
+31 (0)161 22 64 72

Finance & Administration  
+31 (0)161 22 35 11

Warehouse & Logistics  
+31 (0)161 23 18 28

### **E-mail:**

General  
info@cepro.eu

Sales  
sales@cepro.eu

Finance & Administration  
fa@cepro.eu

Warehouse & Logistics  
logistics@cepro.eu